

## Fracture behavior of concrete made with sintered fly ash lightweight coarse aggregate in comparison to normal weight concrete

Brijesh Singh<sup>1,\*</sup>, Shamsher Bahadur Singh<sup>2,b</sup>, Sudhirkumar V. Barai<sup>2,c</sup>, P N Ojha<sup>3,d</sup>, Rohit Kumar<sup>3,e</sup>

<sup>1</sup>Birla Institute of Technology & Sciences Pilani, Pilani & Group Manager at National Council for Cement and Building Materials, Ballabgarh, India

<sup>2</sup>Department of Civil Engineering, Birla Institute of Technology and Sciences Pilani, Pilani, India

<sup>3</sup>National Council for Cement and Building Materials, Ballabgarh, India

### Article Info

### Abstract

#### Article history:

Received 07 June 2024

Accepted 19 Aug 2024

#### Keywords:

Sintered fly ash  
lightweight aggregate;  
Normal weight  
concrete;  
Lightweight concrete;  
Fracture energy;  
Load-CMOD;  
Load-deflection;  
Stress intensity factor;  
Characteristic length

Sintered fly ash lightweight aggregate based concrete has been reported to give mechanical and durability properties similar to conventional concrete. But concrete made up of lightweight aggregate possesses lower stiffness and shear strength resulting into a brittle mode of failure due to crack propagating directly inside aggregate which is weak in nature. The study presents findings from the experimental investigation of fracture behavior of concrete made with sintered fly ash lightweight coarse aggregate in comparison to normal weight concrete (NWC) at w/b ratio of 0.5, 0.4 and 0.3. The mixes have been tested for compressive and split tensile strength for both concrete types. On notched beams of size 100x 100 x 500 mm, a three-point bend test has been carried out for both lightweight and normal weight concrete to evaluate fracture parameters. The results of split tensile strength test indicated that the split tensile to compressive strength ratio lies in the range of 5-8% for lightweight concrete and this ratio lies between 5-10% for normal weight concrete. The study indicates comparable fracture behavior for both lightweight and normal weight concrete. The non-linear ascending and descending branches in load vs deflection curve of concrete with sintered fly ash lightweight coarse aggregate can be linked with the non-linearity in tensile type stress-strain behavior and formation of the fracture zone in front of the initial notch. The modulus of elasticity of lightweight concrete is significantly lower than normal concrete. The modulus of elasticity, area under the load deflection curve, tensile strength, fracture behavior etc. needs to be considered appropriately in the non-linear analysis of lightweight concrete.

© 2024 MIM Research Group. All rights reserved.

## 1. Introduction

Sintered fly ash lightweight concrete nowadays is getting used in construction industry because of its reduced dead load, improved durability performance, better thermal and sound insulation along with improved fire resistance [1-2]. Apart from this lower water permeability, lower chloride ion penetration and better corrosion resistance of lightweight concrete (LWC) makes it more durable as compared to normal concrete. The density of structural lightweight aggregate concrete generally varies from 1100 to 1900 kg/m<sup>3</sup> having minimum compressive strength of 17 MPa [3]. Sintered fly ash lightweight aggregate is mainly produced from fly ash through sintering process [1-2]. LWC has improved mechanical, durability and thermal properties but one drawback or limitation of

\*Corresponding author: [brijeshshwagi96@gmail.com](mailto:brijeshshwagi96@gmail.com)

<sup>a</sup> [orcid.org/0000-0002-6512-1968](https://orcid.org/0000-0002-6512-1968); <sup>b</sup> [orcid.org/0000-0001-6847-0701](https://orcid.org/0000-0001-6847-0701); <sup>c</sup> [orcid.org/0000-0001-5100-0607](https://orcid.org/0000-0001-5100-0607);

<sup>d</sup> [0000-0003-1754-4488](https://orcid.org/0000-0003-1754-4488); <sup>e</sup> [orcid.org/0009-0000-6167-375X](https://orcid.org/0009-0000-6167-375X)

DOI: <http://dx.doi.org/10.17515/resm2024.310me0607rs>

Res. Eng. Struct. Mat. Vol. x Iss. x (xxxx) xx-xx

any concrete is its non-ductile (brittle) behavior and low crack resistance. This brittle behavior of concrete limits flexural load carrying capacity and can be extremely critical in earthquakes [3-7]. Due to the brittle nature, concrete structures are bound to undergo cracking under flexural loads and can fail suddenly without showing any signs of warning. The fracture performance of normal concrete has been investigated deeply in the past four to five decades resulting in thorough understanding and development of numerical models related to fracture behavior [5]. The numerous non-linear fracture mechanics models have been developed and are being used such as the fictitious crack model by Hillerborg et al. [6], the crack band model by Bazant et al. [7] and the two-parameter model by Jenq and Shah [8]. These models have been successfully used in the analysis of non-linear behavior of concrete structures. The estimation of brittleness and ductility of concrete can be quantified through its fracture properties [9-11]. RILEM [12-13] gives a three-point bend test procedure on a notched beam to evaluate the fracture properties for concrete. Fracture energy is key fracture parameters used to compare or analyze the concrete cracking resistance and toughness. RILEM defines fracture energy as the quantum of energy needed to develop a crack with unit area. Other than fracture energy, other indicators of fracture behavior are initial load compliance, stress intensity factor, energy release rate, toughness and characteristic length. Fracture toughness can be expressed as ability of brittle material such as concrete to withstand crack formation under loading. The energy release rate is defined as energy transformation rate during propagation of fracture in concrete.

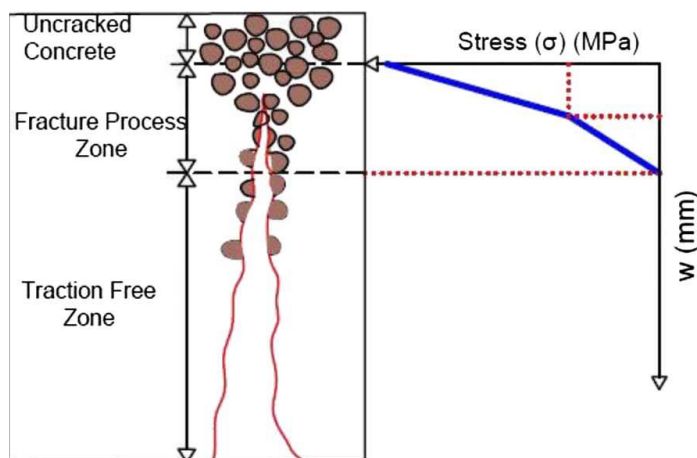

Fig. 1. Stress-crack width response of structural lightweight aggregate concrete [14]

Characteristic length of concrete is indicator of its brittleness and is inversely proportional to characteristic length [9]. In the LWC, there exists three fracture zones (a) traction free zone, (b) fracture process zone, (c) un-cracked zone (Figure-1) [14]. The traction across the coherent surface goes up to maximum load and thereafter drastically reaches to zero as per the multilinear stress-crack width model (Figure-1) [14]. Trivedi et al. [15] studied three approaches for determining fracture behavior of concrete such as Bi-linear approximation, RILEM procedure, and energy release rate to evaluate the fracture energy independent of size and observed similar results suggesting that either of three approaches are applicable. Study done by Murthy et al. [16] on tension softening relation and fracture energy for nano concrete highlighted that notch/depth has a major influence when RILEM method is used for fracture energy determination. Studies on the effect of silica fume as supplementary cementitious materials in normal weight concrete along with distribution of various sizes of aggregate on its fracture behavior are reported by Gil et al. [17] wherein an optimum dose of silica fume for fracture toughness and peak strength has

been reported. According to Siregar et al. [18], ductility of high-strength concrete is affected by the w/b and size of aggregate wherein the aggregate strength decides peak fracture energy.

The study of literature has indicated that numerous studies are carried out on the performance of structural grade lightweight concrete using natural or artificial lightweight aggregate and has evaluated its mechanical and durability performance. However, studies on fracture performance of sintered fly ash lightweight aggregate based concrete is scanty. The comparison of fracture energy and related parameters of plain lightweight concrete with sintered fly ash lightweight coarse aggregate in comparison to normal weight concrete with natural coarse aggregate is not available in the literature. The current study also investigates the water absorption potential for dry state sintered fly ash lightweight aggregate from cement matrix. The paper presents a simplified mix design procedure for lightweight concrete produced from commercially available sintered fly ash lightweight aggregate. The findings of the study will highlight modulus of elasticity, load vs deflection behavior, tensile properties, fracture phenomena, brittleness, crack propagation etc. of LWC compared to normal concrete which would help in non-linear analysis of critical structures such as buildings in high seismic zones, dams, nuclear structures etc. where unstable and sudden crack propagation could lead to disaster. The study findings will also promote enhancement in adoption of sintered fly ash lightweight coarse aggregate in concrete in construction industry leading to conservation of natural resources and production of sustainable concrete.

The study presents findings from the experimental results of fracture behavior of concrete made with sintered fly ash lightweight coarse aggregate in comparison to normal weight concrete (NWC). The w/b ratio adopted for concrete mix preparation has been 0.5, 0.4 and 0.3 wherein (a) three mixes has been prepared with sintered fly ash lightweight coarse aggregate and (b) three mixes has been prepared with natural granite coarse aggregate. The 28-day cube compressive and split tensile strength are determined as procedure given in IS code [19]. The three mixes have shown compressive strength of 39.25, 51.52 and 58.73 MPa for concrete made with sintered fly ash lightweight coarse aggregate. The three mixes have shown compressive strength of 43.35, 55.72 and 68.93 MPa for concrete made with natural granite coarse aggregate. The fracture energy is calculated as per RILEM procedure. Fracture performance has been evaluated at 28-day by determining modulus of elasticity, fracture energy, initial load compliance, energy release rate, stress intensity factor and characteristic length

## **2. Materials**

In this study for production of normal weight concrete, OPC cement (43 Grade), coarse and fine aggregates, silica fume, superplasticizer and water are used. In the study, crushed fine aggregate that conforms with Zone II of IS: 383-2016 [20] has been used as fine aggregate and coarse aggregate having maximum nominal size of 20 mm has been used. Figure 2(a) displays the fine aggregate, while Figure 2(b) displays the coarse aggregate. Table 1 displays the physical characteristics of both coarse and fine aggregate.

The mechanical characteristics of sintered fly ash coarse aggregate is presented in Table-2. The sintered fly ash lightweight aggregate is brown in color as shown in Figure-3 and has black core. The microstructure of sintered fly ash lightweight aggregate has been shown in Figure-4. The samples of sintered fly ash lightweight aggregate (LWA) (two fractions 8-16 mm and 4-8 mm) have been used as coarse aggregate. The chemical composition of sintered fly ash lightweight aggregate, OPC cement 43 grade (as per IS: 269 [21]) and silica fume is given in Table-3. The fineness of OPC cement is 320 m<sup>2</sup>/kg and silica fume is 22000 m<sup>2</sup>/kg.



Fig. 2. (a) Fine aggregate (stone dust) and (b) Coarse aggregate (granite)



Fig. 3. (a) Sintered fly ash lightweight aggregate, Fraction: 4-8 mm and (b) Sintered fly ash lightweight aggregate, fraction: 8-16 mm

Table 1. Aggregates properties

Property	Granite		Sintered Fly ash Lightweight Aggregate		Fine Aggregate
	20 mm	10 mm	8-16 mm	4-8 mm	
Specific gravity	2.82	2.81	1.49	1.47	2.65
Water absorption (%)	0.3	0.3	17.93	17.50	0.59
Sieve Analysis	20mm	97	100	100	100
	10 mm	2	66	30	100
	4.75	0	2	0	13
	2.36	0	0	0	2
	1.18	0	0	0	0
Percentage Passing (%)	600 $\mu$	0	0	0	43
	300 $\mu$	0	0	0	26
	150 $\mu$	0	0	0	14
	Pan	0	0	00	0

For preparation of concrete mixes for LWC, the fine aggregate (crushed stone) used in study conforms to IS: 383-2016. Also, for LWC crushed fine aggregate that conforms with Zone II of IS: 383-2016 [20] has been used as fine aggregate. The polycarboxylic type chemical admixture conforming to Indian Standard IS:9103[22] has been used for all mixes.



Fig. 4. Microstructure of sintered fly ash lightweight aggregate (10  $\mu$ m and 1.5x)

Table 2. Mechanical properties of sintered fly ash lightweight aggregate used in study

Fraction	LWA designation	Specific gravity	Water absorption at 24 hours (%)	Loose bulk density (kg/m <sup>3</sup> )	Crushing Strength (N/mm <sup>2</sup> )	10 % Fines (Ton)
4-8 mm	LWA-I	1.47	17.50	813	8.80	-
8-16 mm	LWA-II	1.49	17.93	849	7.70	3.60

Table 3. Chemical composition of sintered fly ash lightweight aggregate and OPC cement

Component	CaO (%)	SiO <sub>2</sub> (%)	Al <sub>2</sub> O <sub>3</sub> (%)	Fe <sub>2</sub> O <sub>3</sub> (%)	SO <sub>3</sub> (%)	MgO (%)	Na <sub>2</sub> O Equivalent (%)	Loss of Ignition
Sintered fly ash lightweight aggregate	2.45	62.50	25.85	4.19	0.29	0.53	0.77	1.48
Cement OPC 43 grade	59.60	21.22	7.19	4.25	2.50	1.90	1.05	1.94
Silica fume	-	95.02	-	0.80	-	-	-	1.16

### 3. Concrete Mix Design and Details of Specimen

#### 3.1. Concrete Mix Design

##### 3.1.1 Normal Concrete Mix Design

The w/b ratio adopted for concrete mix preparation has been 0.5, 0.4 and 0.3 wherein (a) three mixes has been prepared with sintered fly ash lightweight coarse aggregate and (b) three mixes has been prepared with natural granite coarse aggregate. The slump has been kept in between 75 -100 mm. The mix design for normal weight concrete has been done in accordance with procedure given in IS: 10262-2019 [23]. The details of concrete mix are given in Table-4.

Table 4. Mix design details for normal weight concrete

w/b	Total Cementitious Content [Cement + Silica Fume (SF)] (Kg/m <sup>3</sup> )	Water Content (Kg/m <sup>3</sup> )	Admixture % by weight of Cement	Fine Aggregate (Kg/m <sup>3</sup> )	Coarse Aggregate 20 mm (Kg/m <sup>3</sup> )	Coarse Aggregate 10 mm (Kg/m <sup>3</sup> )	28-Day strength of concrete (N/mm <sup>2</sup> )
0.50	340 (316+24)	170	0.50	660	775	516	43.35
0.40	425 (382+43)	170	0.80	580	775	515	55.72
0.30	566 (481+85)	170	1.00	493	742	495	68.93

### 3.1.2 Lightweight Concrete (LWC) Mix Design

The sintered fly ash lightweight aggregate is porous in nature with very high-water absorption as compared to conventional natural aggregate. When lightweight aggregate is added in dry condition with water correction equal to water absorption of aggregate, it leads to segregation of mix in fresh state as well increase in net free water to cement ratio leading to reduction in strength in hardened state. Secondly, the direct correction of water absorption does not take into account the effect of cement paste and in actual condition it is the cement paste and not water alone which dictates the water absorption potential of lightweight aggregates. This problem can be tackled by use of lightweight aggregate in dry state condition with appropriate correction in water absorption taking into account the effect of cement paste for given water cement ratio of concrete mix.

The mix design for LWC with sintered fly ash lightweight coarse aggregate has been done in accordance with procedure given in Indian Standard IS: 10262-2019 [23] and curve has been developed for water absorption correction of aggregate. The sintered fly ash lightweight aggregate is highly porous and its water absorption is about 18 percent. In the present study, the combined aggregate grading given in IS: 9142-2018 [24] has been adopted. The absorption potential of sintered fly ash lightweight aggregate has been determined in the study wherein moisture content of lightweight aggregates have been known. Initially the moisture content and initial weight of the aggregate have been recorded. The mortar pastes of w/b 0.7 has been prepared and placed in container. Twenty-five aggregates have been first placed in a cement paste present in the container for each period of 5, 15, 30, 45 and 60 minutes to decide optimum absorption period (soaking period). After the specified period of absorption, the lightweight aggregates have been removed from the cement paste and the excess cement paste attached to the outer surface of aggregates has been separated with help of nylon brush. The removal time of excess paste has been kept not more than one minutes to not absorb the water trapped in the aggregate particles which takes part in further hydration of cement paste. Thereafter, weight of aggregates has been measured. After this the aggregates have been placed inside an oven for period of 48 hours at a temperature of 105°C. Finally, dry weight of aggregate has been determined and aggregate absorption values have been determined. The total absorption by the lightweight coarse aggregate in terms of percentage is calculated as difference of mass of aggregate after 45 minutes of soaking and initial mass of aggregate before soaking divided by initial mass of aggregate before soaking multiplied by 100. The total water absorption by the lightweight coarse aggregate in terms of percentage is calculated as difference of mass of aggregate after 45 minutes of soaking and dry mass of aggregate after oven drying divided by dry mass of aggregate after oven drying multiplied by 100. The difference between the percentage of total absorption by the lightweight coarse aggregate and total water absorption by the lightweight coarse aggregate is termed as total paste absorption potential of lightweight coarse aggregate.

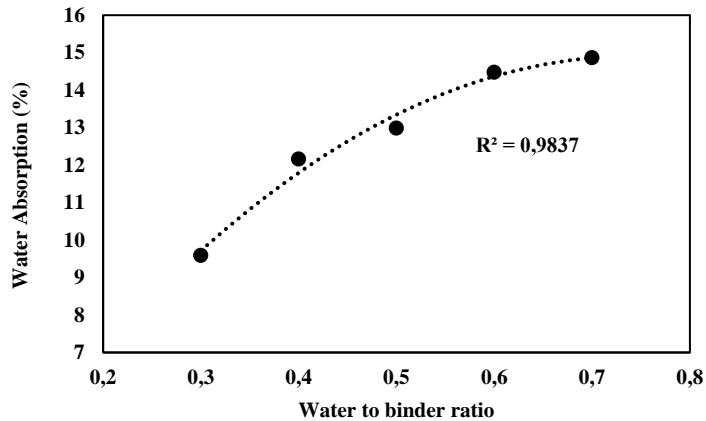

Fig. 5. Relationship between water absorption of sintered fly ash lightweight aggregate with water to cement ratio for 45 minutes absorption period

The water absorption values at w/b 0.70 for absorption period of 5, 15, 30, 45 and 60 minutes have been 12.84, 13.84, 14.36, 14.86, 14.90, respectively. Based on this study, 45 minutes absorption period for sintered fly ash lightweight aggregate has been considered in this study as the absorption capacity of the aggregates beyond this period has been almost negligible. Thereafter, this exercise has been repeated for mortar paste of w/b ratio of 0.3, 0.4, 0.5 and 0.6. Thereafter, correlation has been developed between sintered fly ash lightweight aggregate water absorption potential and different w/b ratios. The correlation developed is presented in Figure-5 for absorption period of 45 minutes. The correlation developed is to be used in water absorption correction of sintered fly ash lightweight aggregate used as coarse aggregate in concrete mix preparation. The brief of mix design procedure developed for production of concrete with sintered fly ash lightweight aggregate is given below:

- Step 1: Deciding w/b - w/b is main strength deciding factor for any concrete mix with all types of aggregate.
- Step 2: Fixing the quantity of water for mix-The quantity of water ( $\text{kg}/\text{m}^3$ ) is decided based on the workability requirements of mix for specific situation. The free water content for sintered fly ash lightweight aggregate may be kept in range of  $160 \text{ kg}/\text{m}^3$  to  $210 \text{ kg}/\text{m}^3$ . The guidance on free water content is taken here from ACI 211.
- Step 3: Determining cement content-The cement content ( $\text{kg}/\text{m}^3$ ) is determined by dividing free water content by water to cement ratio.
- Step 4: Determining coarse and fine aggregates-The present method considers coarse aggregate (sintered fly ash lightweight aggregate) and fine aggregate based on the procedure given in IS: 10262-2019. An absolute volume approach is adopted in beginning for determining the quantity of total aggregate. Two fractions (8-16 mm and 4-8 mm) of sintered fly ash lightweight coarse aggregate has been used for mix proportioning. The coarse aggregate of both fractions has been combined in 60 % coarse aggregate 8-16 mm fraction and 40 % coarse aggregate 4-8 mm fraction. The combined aggregate grading meets the requirement of standard aggregate

grading curve limit as per IS: 9142-2018. The water absorption correction for both fractions of sintered fly ash lightweight coarse aggregate and fine aggregate has been done. To consider the absorbed water by aggregate at the time of mixing of concrete, relationship between water absorption of sintered fly ash lightweight aggregate with water to cement ratio given in Figure-5 has been adopted for calculating additional water requirements for lightweight aggregate in dry state condition.

- Step 5: Water absorption correction-The mass of compensated water required is determined as given below:
  - ⇒ Mass of additional water for coarse aggregate= Weight of coarse aggregate\* water absorption potential of aggregate at the time of mixing
  - ⇒ Mass of extra water for coarse aggregate 8-16 mm= Weight of coarse aggregate 8-16 mm\*total water absorption of aggregate related to chosen w/b
  - ⇒ Mass of extra water for coarse aggregate 4-8 mm Weight of coarse aggregate 4-8 mm\*total water absorption of aggregate related to chosen w/b
  
- Step 6: Modification in concrete mix proportion-Whenever the compressive strength and workability requirements are not achieved, then proper modifications need to be done in concrete mixes along with dose of admixture until desired workability and strength properties of LWC has been achieved.

The mix design details of LWC have been given in Table-5. A 60 kg batch of concrete has been prepared for each concrete mix. Firstly, in the pan mixer both the fractions of lightweight coarse aggregate, fine aggregate and cement has been mixed to obtain homogenous mix and thereafter 80 percent water has been added and mixing has been done for period of 2-3 minutes. After that the remaining 20 percent water along with admixture has been added and mixing has been continued for another 2-3 minutes. It is to be noted that the initial mixing period is critical for sintered fly ash lightweight aggregate due to its absorption characteristics. Adjustment has been made in mixing water as a correction for aggregate water absorption.

Table 5. Concrete mix design of LWC

w/b	Total Cementitious Content [Cement + Silica Fume (SF)] (Kg/m <sup>3</sup> )	Total water including aggregate water absorption correction (kg/m <sup>3</sup> )	Admixture % by weight of Cement	Fine Aggregate (Kg/m <sup>3</sup> )	Coarse Aggregate 10 mm (Kg/m <sup>3</sup> )	Coarse Aggregate 20 mm (Kg/m <sup>3</sup> )	28-Day strength of concrete (N/mm <sup>2</sup> )
0.50	340 (316+24)	260	0.60	708	252	390	39.25
0.40	425 (382+43)	254	0.70	646	250	385	51.52
0.30	566 (481+85)	234	0.80	573	246	371	58.73

The molds have been cleaned properly and concrete cube has been compacted on vibration table wherein each of three layers have been properly compacted. The concrete cubes have been demoulded after 24-hours. The environmental conditions of laboratory have been 27±2°C temperature and 65% or more relative humidity. The concrete cube specimen has been tested in surface dried saturated condition. The concrete has been developed to maintain a slump in between 75-100 mm.

### 3.2. Details of Specimen

The concrete specimens of different size have been prepared for various tests discussed hereunder as per the standards and literature. The 28-day cube compressive strength has



been determined as per procedure given in IS:516-2021 on cube size of 150 mm x 150 mm x 150 mm. The concrete cylinders of size 150 mm diameter and 300 mm height were cast for evaluating split tensile strength of concrete as per IS: 516-2021. For fracture study at 28-day age as per literature and RILEM procedure, the three point bend test has been performed on 100mm x 100mm x 500mm size concrete beam with notch depth as 35mm (Figure-6). Table 6 gives details of specimens and Figure 5 displays the cast samples with molds.



Fig. 5 Concrete cubes, cylinders, and beams in molds



Fig. 6. Notched beam sample

Table 6. Details of specimen and tests performed

S. No.	Specimen	Dimension(mm)	Tests
1	Concrete Cubes	150 x150 x 150	Compressive strength at 28-day age
2	Concrete Cylinders	150 Diameter x 300 height	Split Tensile strength at 28-day age
3	Concrete Beams	100 x 100 x 500	3-Point bend test for fracture study

#### 4. Experimental Method

The procedure adopted for determining fracture parameters are discussed in this section. The investigation includes compressive and split tensile strength and fracture parameter on notched beams using 3-point bend test.

##### 4.1. 28-day Compressive and Split Tensile Strength Test

The 28-day cube compressive strength and 28-day split tensile strength has been determined as per IS: 516. These tests have been carried out on three specimens in a compression testing machine of capacity 3000 kN and the average value has been presented.

##### 4.2. Study on Fracture Behavior Using Three-Point Bending Test

On notched beams of size 100 x 100 x 500 mm, a three point bend test has been carried out for both lightweight and normal weight concrete. The plot of Load vs CMOD (Crack Mouth Opening Displacement) and Load vs deflection have been used for determining the fracture behaviour of both types of concrete using various standards and RILEM recommendations. Fracture performance has been evaluated by determining modulus of elasticity, fracture energy, initial load compliance, energy release rate, stress intensity factor and characteristic length. In Figure-7 & Figure-8(a), the three point bend test

diagram and in Figure 8 the test set up in laboratory has been shown. The 100mm x 100mm x 500mm size beam with a notch depth of 35mm has been created in middle of beam and clear span has been kept as 400 mm.

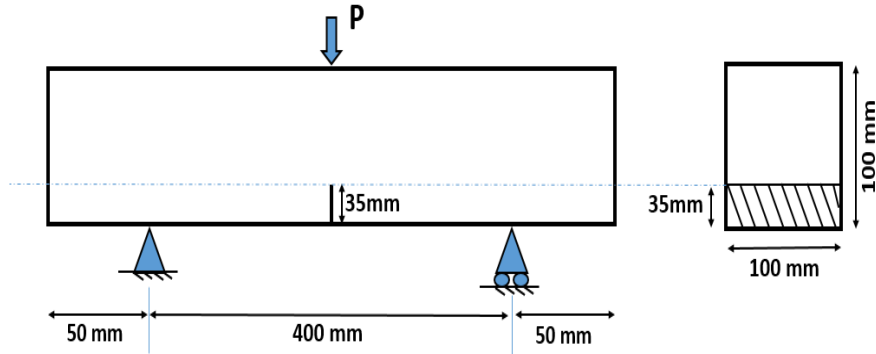

Fig. 7. Three-point bend test diagram

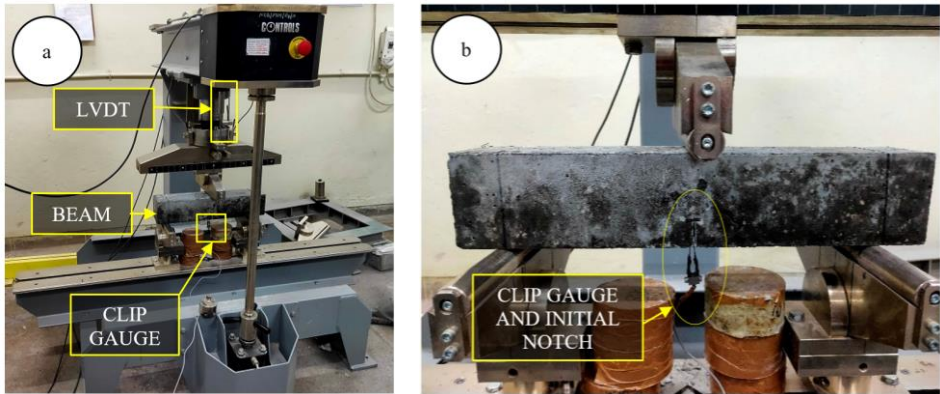

Fig. 8. (a) Typical setup for three-point bend test and (b) CMOD measurement using clip gauge

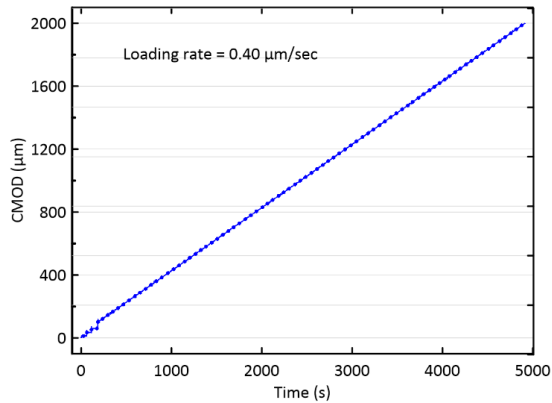

Fig. 9. Crack Mouth Opening Displacement (CMOD) vs time plot for the test

The load on beam specimen has been given through a displacement mode operated machine of 30T capacity. The mid-point beam deflection has been recorded using Crack Mouth Opening Displacement (CMOD) and Linear Variable Displacement Transducer (LVDT). The clip gauge using two nos. steel type knife edges have been placed at the bottom of the beam for CMOD measurement as shown in Figure 8(b). Eighteen concrete beams have been evaluated for fracture performance study and out of which for each mix given in Table 4 and Table 5, the three beam specimens have been tested. The plot of CMOD vs time is shown in Figure-9. The test has been conducted in displacement operated mode in machine and loading rate for CMOD has been maintained at  $0.40\mu\text{m/s}$ . The experiment continued to the point of failure of beam or to point where CMOD has been  $1000\mu\text{m}$ .

## 5. Test Results and Discussions

### 5.1. 28-day Compressive and Split Tensile Strength Test

Table 7 shows the results of the 28-day cube compressive strength and split tensile strength. The three mixes have shown compressive strength of 39.25, 51.52 and 58.73 MPa for LWC made with sintered fly ash lightweight coarse aggregate. The three mixes have shown compressive strength of 43.35, 55.72 and 68.93 MPa for normal weight concrete (NWC) made with natural granite coarse aggregate. From the results it is seen that split tensile to compressive strength ratio lies in between 5-8% for LWC. Whereas in the case of conventional concrete this ratio lies between 5-10%.



Fig. 10. Fractured LWC after split tensile test

Table 7. 28-day cube compressive strength and split tensile strength

w/b ratio	Type	28-day strength (MPa)	
		Cube Strength	Split Tensile Strength
0.50	LWC	39.25	2.26
0.40	LWC	51.52	3.08
0.30	LWC	58.73	3.20
0.50	NWC	43.35	3.76
0.40	NWC	55.72	3.90
0.30	NWC	68.93	4.42

This indicates that the tensile strength to compressive strength ratio of LWC is almost comparable to normal concrete [25]. The results indicate that the split tensile strength of both concrete types improves with reduction in w/b ratio. The observation of spitted

surface of specimen indicates that the fracture path gets transferred through the aggregates in LWC (Figure-10). In case of LWC, it can be inferred that the bond between the cement paste matrix and the sintered fly ash lightweight aggregates are higher than the strength of aggregate. Because of low crushing strength of sintered fly ash lightweight aggregate compared to natural aggregate, the LWC could not give similar split tensile strength for similar w/b ratio.

## 5.2 Load-CMOD and Load-Deflection Behavior

This section discusses the study of load-deflection and load-CMOD behavior of LWC and NWC for w/b ratio of 0.5, 0.4, 0.3 in Figures 11, 12 and 13, respectively. These graphs are used for the subsequent calculation of fracture parameters till the point of failure. The failure point is represented by sudden change in deflection without increase in load in load-deflection curve or sudden change in deflection without increase in load in load-CMOD curve. The comparison of load-CMOD and load-deflection behavior of LWC and NWC for all three concrete mixes indicates that ascending branches of load-deflection and load-CMOD curves of concrete with sintered fly ash lightweight coarse aggregate are similar to normal weight concrete. The non-linear ascending and descending branches in flexural curves of concrete with sintered fly ash lightweight coarse aggregate can be linked with the non-linearity in tensile mode stress-strain behavior and formation of the process zone of fracture in front of the initial notch. The significant difference in elastic modulus of aggregate and cement paste in LWC system with w/b ratio of 0.3 gives further non-linearity in load-CMOD curves and load-deflection of concrete with sintered fly ash lightweight coarse aggregate.

In LWC with w/b 0.3, larger fracture process zone gets developed before the peak because of weaker aggregate to paste bond. The exact reason behind the flat flexural curves in LWC compared to normal weight concrete is not fully understood and one of the reasons can be tortuous crack path in LWC compared to normal concrete. The hard out shell of sintered fly ash lightweight aggregate also provides some crack resistance because of which more crack formation gets diverted to aggregate-cement paste bond than across aggregates particularly for high strength LWC.

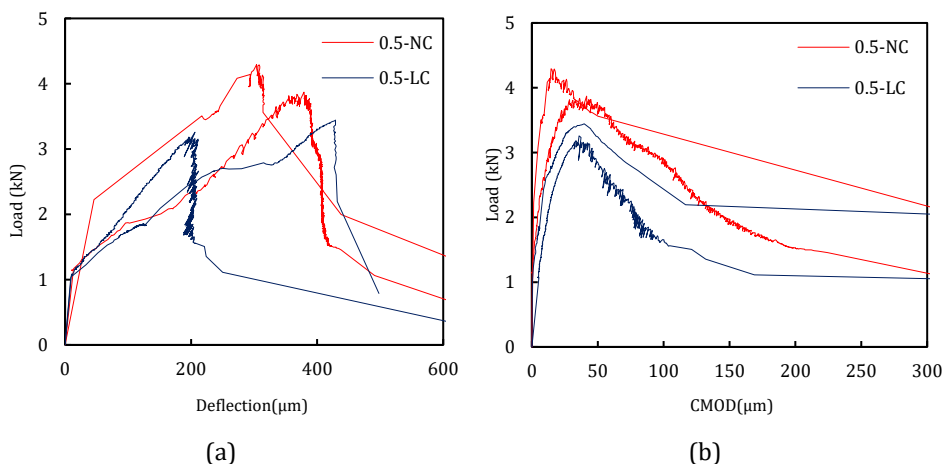

Fig. 11. w/b ratio 0.5 (a) Load Vs deflection curve and (b) Load Vs CMOD curve

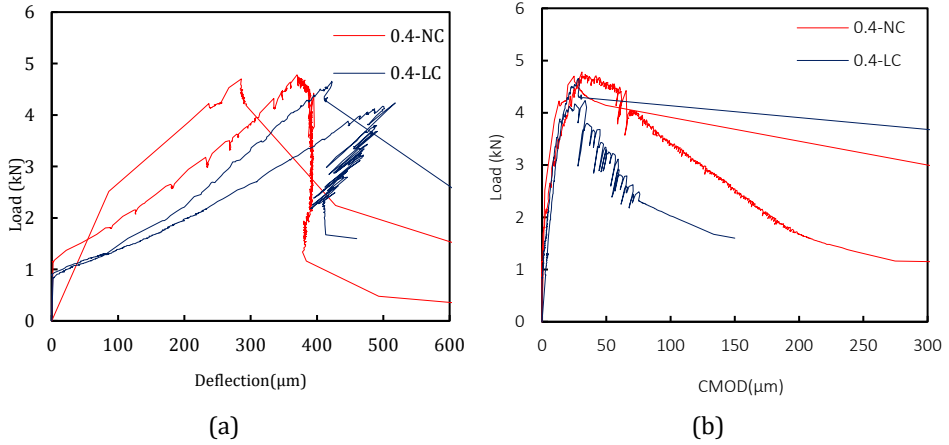

Fig. 12. w/b ratio 0.4 (a) Load Vs deflection curve and (b) Load Vs CMOD curve

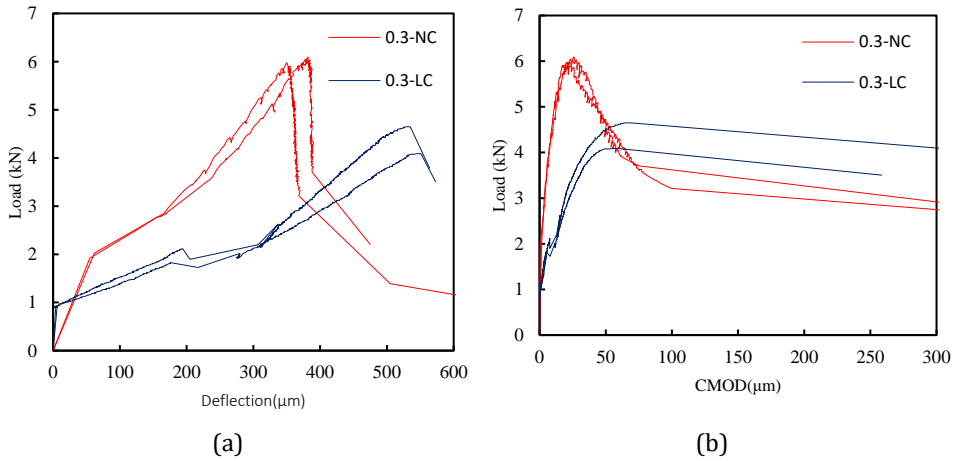

Fig. 13. w/b ratio 0.30 (a) Load Vs deflection curve and (b) Load Vs CMOD curve

### 5.3 Fracture Energy

Fracture energy can be termed as the quantum of energy needed to develop a crack with unit area, it is denoted by  $G_f$ . It is a critical parameter that is used to examine and assess concrete crack resistance, brittleness and toughness. Fracture energy is calculated by the formula from RILEM 50 [12] given in (1);

$$G_f(N/m) = (W_o + mg\delta_o)/A_{lig} \quad (1)$$

where,

$G_f$  = Fracture energy

$W_o$  = Area below the load-deflection plot as shown in Figure 14.

$m$  = beam mass between the support along with mass of loading arrangement which is not attached to machine

$g$  = Acceleration due to gravity, i.e., 9.81 m/s<sup>2</sup>.

$\delta_o$  = Deflection of the specimen at failure

$A_{lig}$  = Area of the ligament

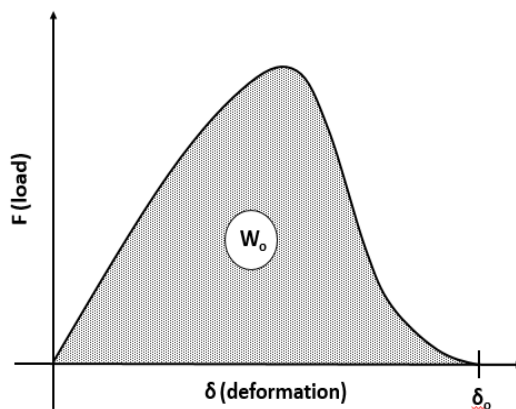

Fig. 14. Area within load and mid-point deflection plot of beam [27]

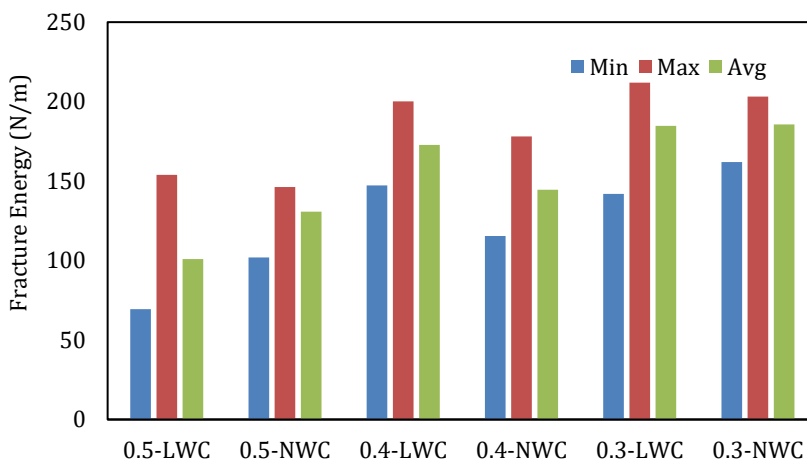

Fig. 15. Fracture energy for w/b ratio of 0.47, 0.36 and 0.20

The comparison of fracture energy of the mix of LWC and NWC at different w/b ratio is presented in Figure 15. The fracture energy in case of NWC increases with increase in strength or with decrease in w/b ratio. The same pattern for fracture energy is observed for LWC. It is also observed that fracture energy for LWC and NWC for w/b ratio 0.3 is comparable but for LWC and NWC for w/b ratio 0.4 and 0.5 the difference is in tune of 19-30%. The difference in fracture energy of LWC and NWC is getting reduced with decrease in w/b ratio. In LWC with w/b ratio 0.3 having compressive strength up to 58 MPa, the difference in the elastic modulus of cement paste and lightweight aggregate is less and the paste-aggregate bond improves. Along with this the improved interfacial transition zone provides better crack resistance compared to LWC with w/b 0.5 or w/b 0.4 leading to similar fracture energy for w/b ratio 0.3. The fracture energy of both LWC and NWC for respective w/b ratio depends upon the type of aggregate and bond of the cement paste-aggregate matrix. In the lightweight concrete, uniform stress distribution happens due to similar moduli of aggregate and cement paste causing simultaneously reduction in stress concentration. The failure of lightweight concrete

happens in brittle manner once fracture initiates due to inferior aggregate interlocking mechanism. The past studies [14-15] has reported that fracture in lightweight aggregate is bound to happen through the aggregate but in case of sintered fly ash lightweight aggregate based concrete, the fracture is happening around the aggregate. The reason behind this phenomenon can be attributed to development of large stress at interface of lightweight aggregate and cement matrix due to incompatibility of elastic modulus of both aggregate and cement matrix. This fact can also be linked with improved interfacial transition zone in case of sintered fly ash lightweight aggregate based concrete due to internal curing and prolonged hydration.

#### 5.4 Modulus of Elasticity (MOE) and Initial Compliance

Initial compliance represented by  $C_i$ , is defined as the inverse of the slope of the initial linear portion of the load versus CMOD curve. Equation (2), as given by [12], is used to get the MOE for the concrete beams with midpoint notch using the  $C_i$ .

$$E \text{ (MPa)} = 6S \frac{\alpha V_1(\alpha)}{C_i d b^2} \quad (2)$$

Where  $\alpha = a/d$ ,  $a$ = initial notch depth,  $d$ = beam depth. The computation of the slope of the load-CMOD curve's initial straight segment is displayed in Figure 13. Equation (3) provided by Tada et al. [25] is used to determine  $V_1(\alpha)$  as follows:

$$V_1(\alpha) = 0.76 - 2.28\alpha + 3.87\alpha^2 - 2.04\alpha^3 + \frac{0.66}{(1 - \alpha)^2} \quad (3)$$

Table 8 presents the value of MOE as obtained from initial compliance by using equation 2. It can be observed that load-CMOD compliance method for MOE gives higher result than the actual as the strength of concrete increases. The MOE by this method is not accurate and reliable, therefore MOE as per empirical equation by Arora et al. [26] for normal weight concrete and IS: 9142-2018 for LWC is used for calculation of subsequent parameters in the study.

Table 8. Modulus of elasticity and initial compliance of concrete

w/ b ratio	Cube compressive strength (MPa)	Initial compliance $C_i$ ( $10^{-9}$ m/N)	Modulus of elasticity (GPa) [CMOD test]	Modulus of elasticity (GPa) [As per Arora et al. For NWC [26] / IS: 9142-2018 for LWC [24]]
0.5-NWC	43.35	5.12	31.33	30.98
0.5-LWC	39.25	6.87	23.35	18.79
0.4-NWC	55.72	4.48	35.79	33.43
0.4-LWC	51.52	3.92	40.90	21.53
0.3-NWC	68.93	3.56	45.37	35.60
0.3-LWC	58.73	5.0	32.10	23.33

The compliance method proposed by RILEM is tedious, difficult, and sensitive to various test parameters. It requires a high degree of measurement sensitivity in mechanical bend tests, in the order of ( $10^{-9}$ ) meters. Compliance is a function of the initial slope, which can vary slightly based on individual graph analyses. Even a little deviation in measuring the initial level slope in load-CMOD curve significantly affects the MOE. Figure 16 shows the best-fit curve for calculating the initial slope of the load-CMOD curve for different w/b ratios of the mix. From this study, it is evident that this method for determining MOE should not be preferred and is limited to use for comparative analysis only. Other well-known standard empirical methods should be used for MOE calculations.

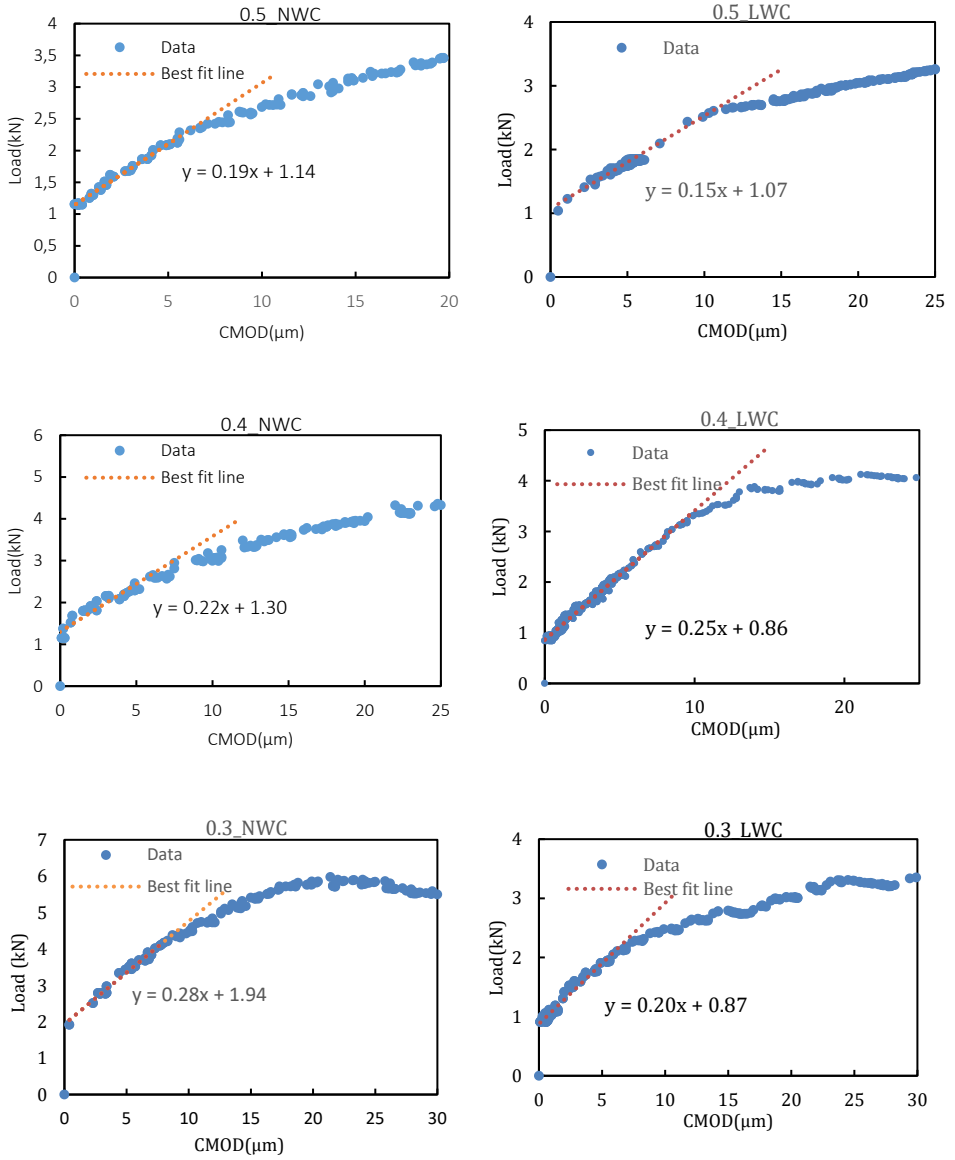

Fig. 16. Initial compliance calculation from Load-CMOD curves

### 5.5 Stress Intensity Factor

The stress intensity factor ( $K_{IC}$ ) is defined as stress measurement adjacent to the crack. It represents the state of stress and crack propagation rate in the neighborhood of the crack or notch tip. The specimen with higher ( $K_{IC}$ ) shows higher stress distribution near the crack representing less brittle the material. According to RILEM [12], the stress intensity factor can be computed using equation (4) as follows:

$$K_{IC} (MPa \sqrt{m}) = 3(P_{Nmax} + 0.5W) \frac{S\sqrt{\pi a}}{2d^2 b} f(\alpha) \quad (4)$$



Where  $P_{Nmax}$  = peak load beam with midpoint notch in N,

$W$  = Total weight of the beam between the supports

$S$  = span of the beam in m

$\alpha = a/d = 0.35$

$f(\alpha)$  = Correction related to geometry for bending load.

For calculation of  $f(\alpha)$  Finite Element Method is required for varying property of material, size and notch depth [27]. But in the present study equation (5) is used for comparative analysis because of simplicity and wide acceptance of this:

$$f(\alpha) = \frac{1.99 - \alpha(1 - \alpha)(2.15 - 3.9\alpha + 2.7\alpha^2)}{\sqrt{\pi}(1 + 2\alpha)(1 - \alpha)^{3/2}} \quad (5)$$

The stress intensity factor test results are shown in Figure 17. The graph shows that the average stress intensity factor for LWC is comparable than the NWC for a  $w/b$  ratio of 0.3, 0.4, and 0.5. The increase in  $w/b$  ratio increases the  $K_{Ic}$  for NWC, almost comparable behavior can be seen with LWC. Also, it can be seen that  $K_{Ic}$  increases with increase in compressive strength of the concrete because formation of initial cracks depends upon the tensile strength of the beam.

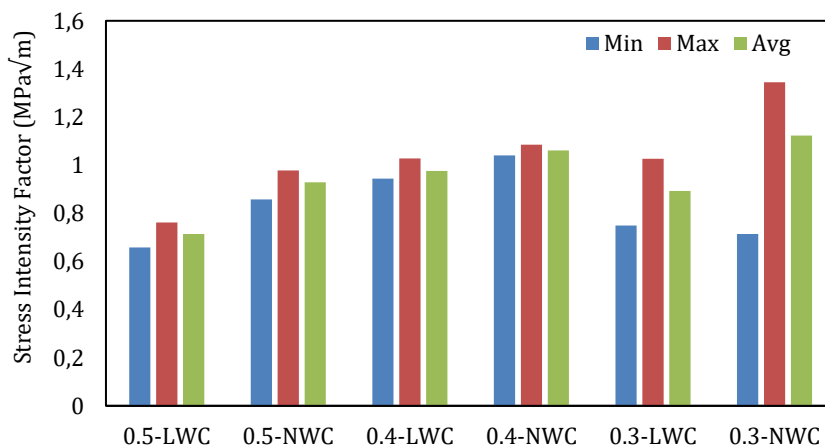

Fig. 17. Stress intensity factor

### 5.6 Critical Energy Release Rate

The critical energy release rate,  $G_{IC}$  is defined as rate of change of energy when new fracture surface is created. It quantifies the energy change associated with crack growth. It can be numerically termed as the reduction in total energy potential per increase in surface area of fracture. It is important parameter to predict fracture toughness and crack growth behavior. The equation given by RILEM [12, 27] and mentioned below in equation (6) is adopted for calculation of  $G_{IC}$ :

$$G_{IC}(N/m) = \frac{K_{Ic}^2}{E} \quad (6)$$

Figure 18 shows the energy release rate of the LWC and NWC mix at  $w/b$  ratio of 0.5, 0.4 and 0.3. The graph clearly shows the slight increase in energy release rate in case of LWC

as compared to NWC for given w/b ratio. It means that for LWC the strain energy release with formation of new crack will be higher than NWC. From the figure, it can be noted that there is no definite trend in energy release rate with increase in compressive strength of both NWC and LWC.

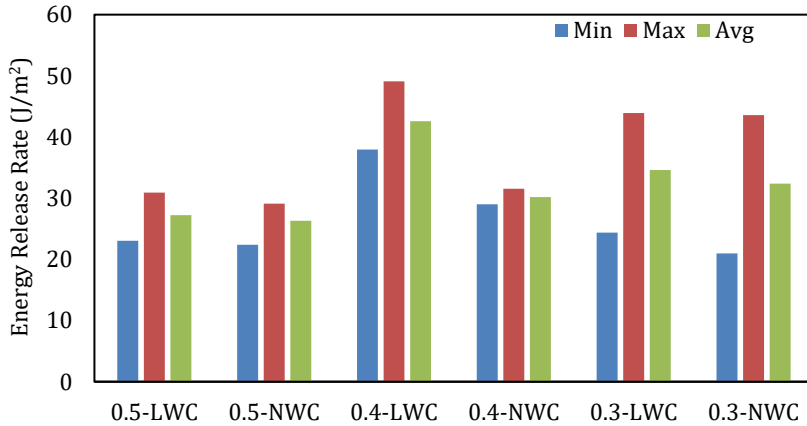

Fig. 18 Energy release rate

### 5.7 Characteristic Length of Concrete

Characteristic length is inherent property of material which indicates smallest possible width of a zone where damage occurs in a non-local continuum model [26]. It indicates the smallest possible spacing of fracture in discrete fracture model. It is calculated to understand and compare the brittleness of two different materials. The lesser the characteristic length, the lesser the spacing of fracture due to easier crack propagation and more brittle the material. It helps to predict how materials will behave when they start to break. The following formula (7) from [27] can be used to compute it. Here  $E$  is elastic modulus,  $G_f$  is fracture energy, and  $f_{st}$  is split tensile strength.

$$L_{ch}(mm) = \frac{EG_f}{f_{st}^2} \quad (7)$$

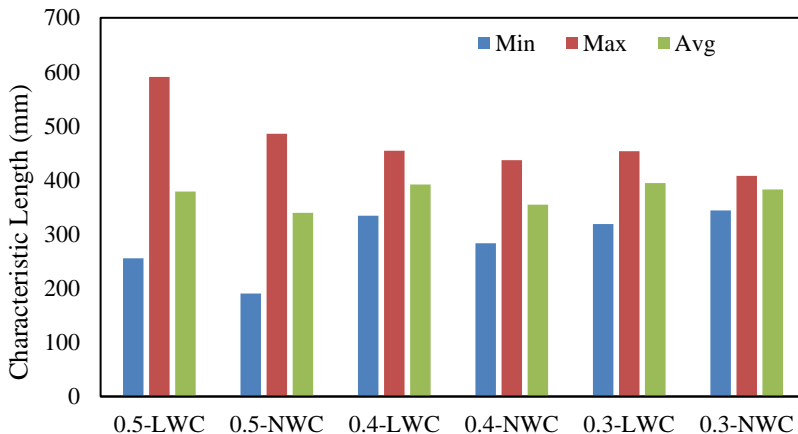

Fig. 19. Characteristic length

Figure 19 shows the characteristic length results, and it can be analyzed from the figure that as the compressive strength increases for NWC there is similar characteristic length. The same trend is observed in case of LWC. At a given water binder ratio, the characteristic length of LWC and NWC are comparable for lower w/b of 0.4 and 0.3 and does not show any significant variation in characteristic length. This indicates that fracture behavior of both LWC and NWC are comparable.

## **6. Conclusions**

Based on the comparison of fracture energy and other fracture parameters adopting the three-point bend test with midpoint loading for plain lightweight concrete with sintered fly ash lightweight coarse aggregate in comparison to normal weight concrete, followings conclusions are drawn:

- Split tensile strength tests shows that lightweight concrete exhibits a split tensile to compressive strength ratio between 5% to 8%, while this ratio ranges from 5% to 10% for normal weight concrete. The modulus of elasticity in case of lightweight concrete is about 60-70% of modulus of elasticity of normal weight concrete.
- The comparison of load-CMOD and load deflection behavior of LWC and NWC indicates that ascending portion of load-deflection and load-CMOD plot of LWC is similar to normal weight concrete. The non-linear ascending and descending branches in flexural curves of lightweight concrete can be correlated with the non-linearity in tensile mode stress-strain behavior and formation of the process zone of fracture in front of the initial notch.
- It can be observed that load-CMOD compliance method for modulus of elasticity gives higher result than the actual as the strength of concrete increases. The modulus of elasticity by initial compliance method is not accurate and reliable. The initial tangent modulus of elasticity as per Indian Standard is used for calculation of subsequent parameters in the study. This compliance method is proposed by RILEM is tedious, difficult and sensitive to test parameters.
- The fracture energy in case of NWC increases with increase in strength or with decrease in w/b ratio. The same trend for fracture energy is observed for LWC. The difference in fracture energy of LWC and NWC is getting reduced with decrease in w/b ratio due to less difference in the elastic modulus of cement paste and lightweight aggregate, improvement in paste-aggregate bond and better interfacial transition zone providing more crack resistance. The stress intensity factor and characteristic length of LWC is comparable to NWC. No definite trend has been noted in energy release rate for both NWC and LWC with increase in compressive strength.
- The modulus of elasticity of LWC is significantly lower than normal concrete. The modulus of elasticity, area under the load deflection curve, tensile strength, fracture behavior etc. needs to be considered appropriately in the non-linear analysis of concrete depending upon type of application such as building, dams, bridges, nuclear structures etc. to compare or analyze the concrete cracking resistance, energy absorption capacity and toughness to estimate the safe period left before unstable and dangerous crack propagation.

## **References**

- [1] Singh B, Singh SB, Barai SV. Performance of concrete made using sintered fly ash lightweight aggregate: A review. *Indian Concr J.* 2023;97(7):41-59.
- [2] Ojha PN, Singh B, Behera AK. Sintered fly ash lightweight aggregate: Its properties and performance in structural concrete. *Indian Concr J.* 2021;95(6):20-30.

- [3] Bate SCC. Guide for structural lightweight aggregate concrete: Report of ACI committee 213. *Int. J Cem Compos Light Concr.* 1979;1(1):5-6. [https://doi.org/10.1016/0262-5075\(79\)90004-6](https://doi.org/10.1016/0262-5075(79)90004-6)
- [4] Bhosale AB, Prakash SS. Crack propagation analysis of synthetic versus steel versus hybrid fibre reinforced concrete beams using digital image correlation technique. *Int J Concr Struct Mater.* 2020;14(1):1-22. <https://doi.org/10.1186/s40069-020-00427-8>
- [5] Cusatisa G, Cedolin L. Two-scale study of concrete fracturing behavior. *Eng Fract Mech.* 2007;74(1-2):3-17. <https://doi.org/10.1016/j.engfracmech.2006.01.021>
- [6] Hillerborg A, Modeer M, Peterson PE. Analysis of crack formation and crack growth in concrete by means fracture mechanics and finite elements. *Cem Concr Res.* 1976;6(6):773-782. [https://doi.org/10.1016/0008-8846\(76\)90007-7](https://doi.org/10.1016/0008-8846(76)90007-7)
- [7] Bazant ZP, Oh BH. Crack band theory for fracture of concrete. *Mater Struct.* 1983;16(3):155-178. <https://doi.org/10.1007/BF02486267>
- [8] Jenq YS, Shah SP. Two parameter fracture model for concrete. *J Eng Mech.* 1983;111(10):1227-1241. [https://doi.org/10.1061/\(ASCE\)0733-9399\(1985\)111:10\(1227\)](https://doi.org/10.1061/(ASCE)0733-9399(1985)111:10(1227))
- [9] Zhang MH, Gjorv OE. Mechanical properties of high strength lightweight concrete. *ACI Mater J.* 1991;88(3):240-247. <https://doi.org/10.14359/1839>
- [10] Patel V, Singh B, Arora VV. Study on fracture behaviour of high strength concrete including effect of steel fiber. *Indian Concr J.* 2020;94(4):1-9.
- [11] Ojha PN, Singh B, Singh A, Patel V, Arora VV. Experimental study on creep and shrinkage behaviour of high strength concrete. *Indian Concr J.* 2021;95(2):30-42.
- [12] RILEM TC-50 FMC. Determination of the fracture energy of mortar and concrete by means of three-point bend tests on notched beams. *Mater Struct.* 1985;18:285-290. <https://doi.org/10.1007/BF02472918>
- [13] Shah SP. Determination of fracture parameters (K<sub>Ics</sub> and CTOD<sub>c</sub>) of plain concrete using three-point bend tests. *Mater Struct.* 1990;23(6):457-460. <https://doi.org/10.1007/BF02472029>
- [14] Sahoo S, Lakavath C, Suriya SS. Experimental and analytical studies on fracture behavior of fiber-reinforced structural lightweight aggregate concrete. *J Mater Civ Eng.* 2021;33(5). [https://doi.org/10.1061/\(ASCE\)MT.1943-5533.0003680](https://doi.org/10.1061/(ASCE)MT.1943-5533.0003680)
- [15] Trivedi N, Singh RK, Jayant C. A comparative study on three approaches to investigate size independent fracture energy of concrete. *Eng Fract Mech.* 2015;138:49-62. <https://doi.org/10.1016/j.engfracmech.2015.03.021>
- [16] Murthy AR, Ganesh P, Kumar SS, Iyer NR. Fracture energy and tension softening relation for nano-modified concrete. *Struct Eng Mech.* 2000;54(6):1201-1216. <https://doi.org/10.12989/sem.2015.54.6.1201>
- [17] Gil DM, Golewski GL. Effect of silica fume and siliceous fly ash addition on the fracture toughness of plain concrete in mode I. *IOP Conf Ser Mater Sci Eng.* 2018. <https://doi.org/10.1088/1757-899X/416/1/012065>
- [18] Siregar APN, Rafiq MI, Mulheron M. Experimental investigation of the effects of aggregate size distribution on the fracture behaviour of high strength concrete. *Constr Build Mater.* 2017;150:252-259. <https://doi.org/10.1016/j.conbuildmat.2017.05.142>
- [19] IS 516 (Part 1/Sec 1). Hardened concrete: Methods of test part 1, testing of strength of hardened concrete, section 1: compressive, flexural and split tensile strength. Bureau of Indian Standards, New Delhi; 2021.
- [20] IS 383. Coarse and fine aggregate for concrete: Specification. Bureau of Indian Standards, Delhi, India; 2016.
- [21] IS 269. Ordinary portland cement: Specification. Bureau of Indian Standards, Delhi, India; 2015.
- [22] IS 9103:1999. Concrete admixtures: Specification. Bureau of Indian Standards, Delhi, India; 1999.

- [23] IS 10262. Concrete mix proportioning: Guidelines. Bureau of Indian Standards, Delhi, India; 2019.
- [24] IS 9142 (Part 2). Artificial lightweight aggregate for concrete: Specification Part 2-Sintered fly ash coarse aggregate. Bureau of Indian Standards, Delhi, India; 2018.
- [25] Arora VV, Singh B, Jain S. Experimental studies on short term mechanical properties of high strength concrete. *Indian Concr J*. 2016;90(10):65-75.
- [26] Arora VV, Singh B, Patel V, Trivedi A. Evaluation of modulus of elasticity for normal and high strength concrete with granite and calc-granulite aggregate. *Struct Concr*. 2021;22(S1). <https://doi.org/10.1002/suco.202000023>
- [27] Ojha PN, Singh P, Singh B, Singh A, Mittal P. Fracture behavior of plain and fiber-reinforced high strength concrete containing high strength steel fiber. *Res Eng Struct Mater*. 2022. <http://dx.doi.org/10.17515/resm2022.377ma1228>