



Research Article

Experimental research of quality of the adhesive repairs of composite structures using non-destructive testing

Kirill Ibrishev^{*a}, Ekaterina Prilipko^b, Maksim Soldatkin^c, Nikolay Kononov^d

Moscow Aviation Institute (National Research University), Moscow, Russia

Article Info

Article History:

Received 12 July 2024

Accepted 18 Dec 2024

Keywords:

Adhesive repair;
Composite materials;
Non-destructive testing;
Honeycomb panels;
Shearography

Abstract

The increasing use of polymer composite materials in aviation necessitates adhesive repairs of aircraft structures in situ, minimizing disassembly and manufacturer return to reduce costs and repair time. This paper discusses the required repair technologies and equipment, as well as the quality analysis and the defect assessment of these repairs through various non-destructive testing (NDT) methods. An experimental investigation was conducted on adhesive repairs of a three-layer carbon fiber panel, evaluating defects qualitatively assessing the applied technologies, and providing recommendations for NDT applicability for this type of sample. The study's analysis produced several key conclusions regarding repair zones. In Zone 1, using the vacuum method, non-adhesions and voids from resin curing were identified, detectable by all NDT methods, with staff qualifications significantly impacting repair quality. In Zone 2, also applying the vacuum method with excess pressure, minor non-adhesions, and voids (2-3 mm) were observed, which were left undetected by rapid NDT (shearography), while detailed NDT (tomography) revealed fewer defects, rating the repair as satisfactory. In Zone 3, utilizing the vacuum method at elevated temperatures, multiple local non-adhesions, and significant delamination (up to 40x40 mm) were discovered, classifying this repair as defective, confirmed by all NDT methods. Smaller defects were only detected by tomography, underscoring the importance of detailed NDT for accurately assessing repair integrity across various technologies.

© 2024 MIM Research Group. All rights reserved.

1. Introduction

During The competitiveness of composite materials significantly depends on the dispersion of physical and mechanical properties, as well as the availability of effective NDT methods for finished products and the complexity of repairing damages during the operation of aircraft **Hata! Başvuru kaynağı bulunamadı..** During the operation of aircraft, products made from polymer composite materials (PCMs) are subjected to random impact influences caused by the environment (both under normal conditions and abnormal natural phenomena); crew errors during take-off and landing; the destruction of units with the formation of non-localized debris; technical staff errors when working on the aircraft; technical staff errors when moving airport equipment; displacement of poorly secured cargo. With the increase in the volume of application of PCM products, the development of new repair technologies and the improvement of existing ones is required.

In the creation of repair techniques, the original design specifications serve as a foundation. These specifications include restoring the rigidity of the original structure, restoring static strength under expected operating conditions up to the limit load, ensuring durability during the remaining service

*Corresponding author: ibrishevKK@mai.ru

^aorcid.org/0009-0006-4345-3335; ^borcid.org/0000-0001-7063-5261; ^corcid.org/0009-0006-6141-5906;

^dorcid.org/0009-0002-2665-4785

DOI: <http://dx.doi.org/10.17515/resm2024.351ma0712rs>

Res. Eng. Struct. Mat. Vol. x Iss. x (xxxx) xx-xx

life of the component, compliance with the requirements for the admissibility of damage to the original part **Hata! Başvuru kaynağı bulunamadı..**

There are many types of PCM product repairs, however, most used ones are mechanical (bolted) and adhesive, as they allow to achieve the mechanical characteristics of the original structure to the greatest extent. These methods are most used in the aviation industry by aircraft operators, but at the same time, they are not universal, as they depend on the type and structure of the repaired object, parameters of the defect, as well as the qualifications of the specialist. While the study primarily focuses on adhesive repair and NDT of three-layer honeycomb PCM, the methodologies discussed are not exclusive to PCM. Various composite structures, such as laminated composites, fiber-reinforced composites, sandwich composites, and carbon fiber reinforced polymers (CFRP), can also benefit from these adhesive repair techniques and NDT procedures. Each composite type may present unique characteristics and defect types that necessitate tailored approaches; however, the fundamental principles of adhesive bonding and NDT remain applicable across different composite materials. Therefore, highlighting these other composite structures is advisable to emphasize the broader relevance of the study's findings.

Repairs using mechanical connections can only be used for thick-walled monolithic structures [3]. Bolted repairs in aviation structures have several drawbacks, including reduced fatigue durability due to stress concentration in the bolt holes, limited applicability to thick-walled structures (not suitable for thin-walled or composite materials), increased weight from added hardware, complexity in installation requiring specialized skills, and restricted flexibility in design. These repairs are generally not advisable for thin-walled composite, curved, or highly loaded components, making their use context-specific and necessitating careful consideration of the repair conditions. The presence of additional holes negatively affects fatigue durability and is a potential place for the initiation of cracks, however, this type of repair allows restoring the strength and rigidity of the structure [4].

At present time, there are several types of adhesive repairs, as they are more suitable for the repair of both monolithic thin-walled and thick-walled claddings of PCM products, as well as for three-layer carbon fiber honeycomb panel. Currently, there are several types of adhesive repairs, as they are more suitable for the repair of both monolithic thin-walled and thick-walled structures of composite materials, as well as for three-layer sandwich panels. Adhesive bonding offers advantages such as even stress distribution, reduced weight compared to mechanical fasteners, and the ability to bond dissimilar materials. Additionally, adhesive repairs can enhance the fatigue resistance of the structures and allow for greater design flexibility.

There are two traditional methods of conducting adhesive repair:

- Vacuum forming using dry fabrics and cold-curing binders. This method has its drawbacks. The lifetime of repaired areas in this way is limited due to the low mechanical characteristics of the adhesive connection. Additionally, we do not use prepreg materials because they are more expensive and require specific storage conditions, which can complicate the repair process. This makes the overall approach less practical for certain applications where cost and ease of handling are crucial.
- Autoclave forming using prepreps in factory conditions. While this method is known for producing high-quality repairs, it has significant disadvantages. The process involves lengthy dismantling, transportation, and repair times at the factory, which can lead to increased downtime and operational inefficiencies. Additionally, using an autoclave is considerably more expensive, adding to the repair cost.

Based on the above-mentioned disadvantages of repair methods, this work will consider a non-autoclave repair method based on impregnated dry fabric.

Currently, several scientific studies explore constructive and technological solutions for performing adhesive repairs under operational conditions **Hata! Başvuru kaynağı bulunamadı..** In [6], the repair process of PCM products with a honeycomb filler is described: the necessary technical equipment for mechanical processing and thermo-vacuum forming.

Adhesive repairs in **Hata! Başvuru kaynağı bulunamadı.**, were carried out using prepregs made for repair tasks with non-autoclave curing. These prepregs offer significant benefits, such as reduced processing time and lower equipment costs, making them suitable for in-situ repairs **Hata! Başvuru kaynağı bulunamadı.** However, challenges remain, including the need for precise temperature control during the curing process and potential limitations in achieving optimal mechanical properties compared to traditional autoclave-cured composites, the advantages and disadvantages of using which are depicted in **Hata! Başvuru kaynağı bulunamadı.** Furthermore, the long-term durability and performance of these repairs under varying environmental conditions require thorough investigation to ensure reliability in aviation applications.

To assess the condition of the repaired products, NDT methods are used, including ultrasound, acoustic, optical, and radiation techniques [10]. These methods allow for the detection of internal defects, such as delaminations, voids, and cracks, without damaging the material. Ultrasound testing is particularly effective for identifying flaws in composite materials, while acoustic emission can monitor structural integrity during loading [11]. Optical methods provide high-resolution imaging, enabling detailed surface inspections. Radiation techniques, such as X-ray or gamma-ray inspection, offer insights into the internal structure of components. By employing a combination of these NDT methods, a comprehensive evaluation of the repair quality can be achieved, ensuring that the repaired products meet safety and performance standards [13].

In several articles experimental work was carried out to determine the applicability of various NDT methods to samples of honeycomb structure with repairs carried out using different technologies [14]. Samples were considered, manufactured according to various technologies; additional samples were prepared with a deliberately violated technological process. The study aimed to evaluate the effectiveness of each NDT method in detecting flaws and assessing the integrity of the repaired structures [15]. Various parameters, such as the size and type of defects, as well as the specific characteristics of the repair techniques used, were analysed. The results indicated that certain NDT methods, such as ultrasonic testing, were more effective in identifying internal defects in repaired samples, while others, namely optical inspection, excelled in detecting surface irregularities. This comprehensive analysis did not only highlight the strengths and limitations of each technique but also provided valuable insights into optimising repair processes and ensuring the reliability of honeycomb structures in practical applications [16]. Further research is suggested to refine these methods and explore their integration for enhanced assessment capabilities [17].

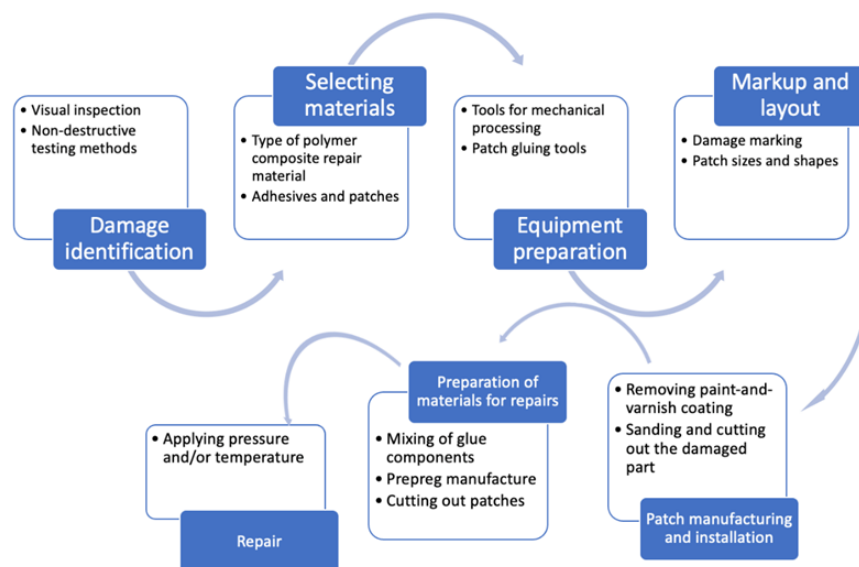

Fig. 1. Overall repair procedure flowchart

Analysing the aforementioned studies, the relevance of this work can be formulated: in light of the difficulties arising from the use of prepreg technology, it is advisable to use adhesive repair technology as the most practical and accessible method, particularly with the rapid assessment

using NDT methods. The analysis provides an opportunity to evaluate the presence of defects in the structure and provides a quality check of the methods used.

The essence of the work is to carry out repairs, quality analysis, and evaluate adhesive repair defects using various NDT methods. The scientific investigation of the repair of a three-layer honeycomb panel made of polymer composite material includes the identification and evaluation of damaged zones by assessing areas with defects for further repair. It involves the selection of materials for repair work, choosing suitable adhesive compositions and materials for restoration. Additionally, it requires the preparation of equipment, gear, and tools for repairing the structures by gathering necessary tools and equipment for the repair process. Marking and laying out damaged areas is crucial, as it involves clearly defining the zones that require repair. The removal of paint from the repair area is necessary for cleaning the surface to ensure high quality adhesion. Mechanical processing of damaged areas prepares the repair zone by removing damaged materials. Furthermore, preparation of adhesive compositions entails mixing adhesive materials according to repair specifications. Cutting out patches layer by layer involves creating patches from material that matches the original structure. Laying out the repair composition includes applying adhesive to the prepared surface. Finally, making the repair patch using the chosen technology completes the repair process by installing the patch according to the selected method. The overall process is presented with a flowchart in figure **Hata! Başvuru kaynağı bulunamadı.**

2. Methods and Materials

2.1 Description of the Control Object

The subject of this research is a three-layer honeycomb panel, consisting of a middle layer of honeycomb filler and external top and bottom skins. The panel is made of composite material, used in the aviation industry. This research focuses on the repair process of the panel, represented in figure 1, to study its structural properties after damage upon impact. Defects are inflicted by singular impacts along the monolithic part of the panel and across the part of the panel with a honeycomb filler from a height of 0.5 meters using a drop test rig with an impact energy of $E = 1.398 \text{ J}$.

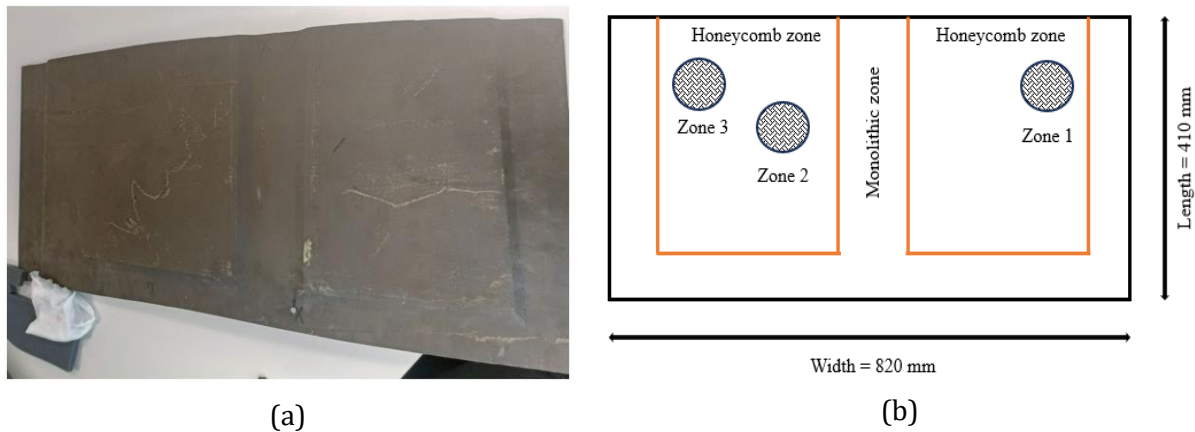

Fig. 1. Repair three-layer carbon fiber honeycomb panel (a) External appearance of the panel (top view); (b) Schematic view of the repair panel with marked repair zones and overall dimensions

3 Description of Repair Technology

3.1. Description of The Repair Device

The existing repair device consists of two blocks: a control unit and a unit for ensuring the necessary technological parameters of the repair process for glued honeycomb and monolithic structures of an aircraft, made of polymer composite materials. The installation provides necessary

pressure (vacuum within the range from negative 0.09 MPa to negative 0.073 MPa and excess up to 1.0 MPa) when gluing (forming) the repair patches.

The difference between the device being developed and those in operation in Russia **Hata! Başvuru kaynağı bulunamadı.** and abroad lies in additional options, among which:

- The possibility of using the control unit at a significant distance from the repair unit;
- The possibility of using excess pressure during repairs, in addition to vacuum pressure, in various combinations: vacuum pressure, combined pressure (vacuum + excess pressure), and only excess pressure. Excess pressure is extremely relevant, practically indispensable for the repair of non-sealed units, on which vacuum pressure is inapplicable;
- The possibility of using not only factory-made heaters but also ones made by the operating organisation, for the thermal regulation of repair zones which significantly reduces the time spent on repair work, and in some cases can be crucial for its implementation.

Four Russian patents **Hata! Başvuru kaynağı bulunamadı.** have been issued on the topic related to the development of the proposed device. The patent **Hata! Başvuru kaynağı bulunamadı.** describes a portable device designed specifically for the repair of polymer items. It emphasises ease of use and mobility, allowing repairs to be conducted in situ. Another patent **Hata! Başvuru kaynağı bulunamadı.** describes a special approach to repairing the aerodynamic surfaces of aircraft using glue. It focuses on methods that ensure strong adhesion and structural integrity, which are crucial to maintaining aerodynamic performance. The patent **Hata! Başvuru kaynağı bulunamadı.** presents a method tailored for situations where access to the repair area is limited to one side. It details techniques that optimise the repair process while ensuring effective bonding and restoration of the material's properties. The patent **Hata! Başvuru kaynağı bulunamadı.** addresses the challenges associated with repairing thin-walled structures, which are often found in aerospace applications. It proposes methods that minimise the risk of further damage during the repair process and enhance the overall durability of the repaired structure.

3.2 Repair Material

Polymer repair adhesive is a two-component composition used in repairs as a filler and an impregnator. The mass of the prepared ACM12K adhesive is obtained after achieving a homogeneous structure by mechanical mixing of the components A and B, the weight ratio of which is indicated on the package and is about 100:30 by weight. The curing time of the adhesive is 2 hours at a temperature greater than 20 °C.

Layers of the repair patch are cut out of a roll of carbon unidirectional tape, considering the size of the separating film on which all layers of the patch are applied. The scientific research of the repair of a three-layer honeycomb panel made of polymer composite material includes the calculation of the schematic arrangement of the patch. The scientific investigation of the repair of a three-layer honeycomb panel made of polymer composite material includes:

- Identification and evaluation of damaged zones;
- Selection of materials for repair work;
- Preparation of equipment, gear, and tools for repairing the structures;
- Marking and laying out damaged areas;
- Removal of paint from the repair area;
- Mechanical processing of damaged areas;
- Preparation of adhesive compositions;
- Cutting out patches layer by layer;
- Laying out the repair composition;
- Making the repair patch using the chosen technology.

According to the scheme presented in figure 2 for the calculation of all patches, placement is performed in the centre of the three-layer honeycomb panel. The patch has a specific geometric shape and sizes, corresponding to the requirements of the calculation of the structure repair. The process of calculating the patch size for the repair of composite structures involves several critical steps. Initially, it is essential to determine the size and shape of the damage by accurately measuring

the affected area. Following this, the selection of the type and size of the patch becomes imperative, as the optimal dimensions are contingent upon both the nature and extent of the damage, as well as the specific materials employed in the composite structure. Subsequently, the design of the patch must be tailored to conform to the contours of the damaged area, thereby ensuring a secure and effective connection. Additionally, it is crucial to consider the overlap; the dimensions of the patch should extend beyond the damaged area by several centimetres (typically 2-5 cm) to guarantee adequate overlap and structural integrity.

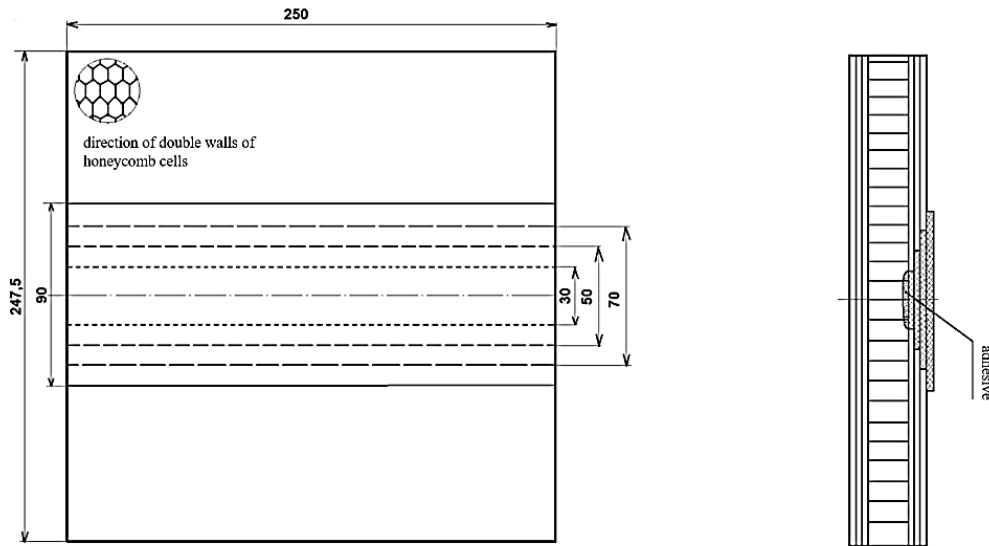

Fig. 2. Scheme of the arrangement of layers of the repair patch

3.3 Repair Types and Technological Modes

3.3.1 Vacuum

The vacuum bag is designed to provide vacuum (suction) and is installed on the repair zone, as shown in Figure 3. Repair under vacuum pressure is performed without heating for 2.0 hours, then the vacuum bag and technological materials are removed from the repair zone.

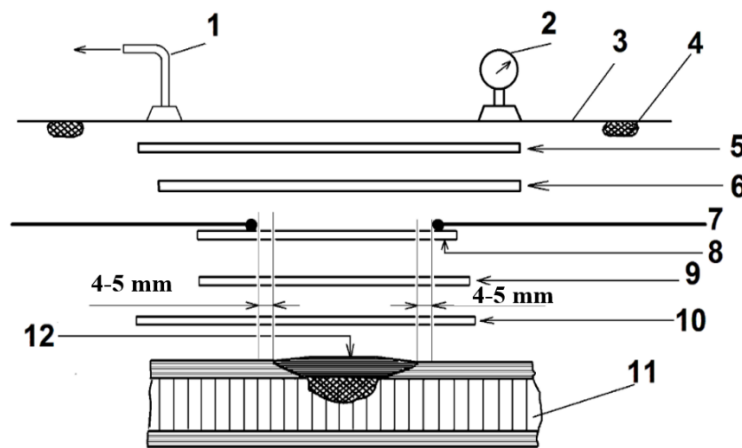

Fig. 3. Assembly scheme of the vacuum bag: 1- air suction; 2- device for controlling the suction in the vacuum bag; 3- vacuum bag shell; 4- sealing gasket; 5- vacuum bag's drainage layer (padding polyester, fiberglass); 6- heater (thermal blanket); 7- thermocouple; 8- non-perforated separating film; 9- layers of fabric absorbing excess resin (glue) – nylon or polyethylene terephthalate; 10- perforated separating film; 11- repaired structure; 12- repair patch layers in the repair zone

3.3.2 Excess Pressure

Excess pressure is the main type of technological pressure when it is impossible to ensure the airtightness of the repair zone (when it is impossible to install a vacuum bag). Providing heating in the repair zone is carried out through a heater (thermal blanket), laid on a non-perforated separating film. The curing temperature of the adhesive is set at 150 degrees Celsius, while the maximum temperature of the thermal blanket can reach up to 200 degrees Celsius. This ensures that the adhesive cures effectively while maintaining the integrity of the surrounding materials.

Air bags in boxes can also be utilised as a source of excess pressure in the repair zones as presented in figure 4, alongside with power elements, clamps, and bags with sand as counterpressure, by which excess pressure can be provided.

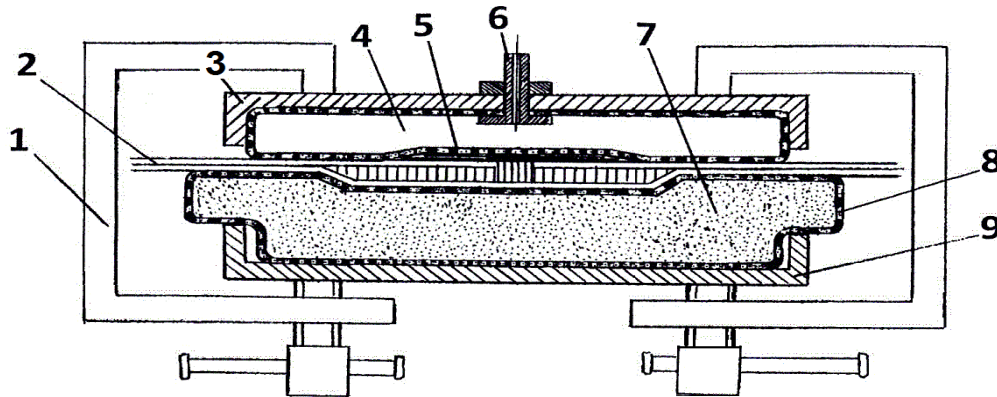

Fig. 4. Scheme of providing excess pressure during repair: 1 - clamp; 2- repaired structure; 3- air bag box; 4- air bag; 5- repair zone; 6- fitting for compressed air supply; 7- sand; 8- shell of the sand-filled bag; 9- the sand-filled bag supports

Two sample zones were repaired using different technologies: the first – vacuum, the second – vacuum with excess pressure, the third – vacuum with exceeding the curing temperature. The repair of the third sample zone was performed with a deliberately violated technology for the guaranteed presence of defects of various nature, which is necessary for the analysis of the detection of these defects by various NDT methods.

4. Description of Non-Destructive Testing Methods

4.1. Tomography

To detect potential defects in repair areas, a non-destructive testing method, X-ray computed tomography (CT), is used. CT provides a detailed analysis of the heterogeneities of the inspected object's structure. A planar radiography system, utilising a laminographic scanning algorithm, is used for this purpose. The research object (in this case, 3 samples with completed repairs) is placed inside the X-ray system, then the operator selects the optimal voltage and current values. To reduce data collection time, the number of projections for each sample is chosen in the range from 700 to 4000.

The process of material tomography involves several key stages: scanning, reconstruction, and post-processing. In the initial phase, scanning, the material is subjected to X-rays or other imaging techniques to capture a series of projections from different angles. This data provides a comprehensive view of the internal structure of the sample. Following the scanning, data reconstruction is performed using third-party software. This software processes the collected projections to create a 3D representation of the object, employing advanced algorithms to accurately reconstruct the internal features based on the scanned data. In the final stage, post-processing is conducted to refine the 3D model. This includes determining the centre of rotation for the sample, selecting a local area of interest, and adjusting the tone curve to enhance visibility and detail. As a result of this post-processing, a detailed 3D model of the research object is produced, allowing for cross-sectional views and further analysis of the material's properties. This

comprehensive approach enables researchers to gain valuable insights into the internal structure and characteristics of materials without destructive testing.

4.2. Shearography

Shearography is an optical express non-destructive testing (NDT) method, which detects material defects through the measurement and analysis of surface deformations. These deformations are formed as a response to the internal structure's external influence. By combining the image of the object in its initial state with the image taken in the excited state, the change in any given point of the image can be determined **Hata! Başvuru kaynağı bulunamadı..** During shearography, the test object's surface is illuminated with laser radiation [24]. The radiation reflected from the object's surface is received by a CCD-camera equipped with "shifting optics", which projects the object's image onto the camera matrix twice. Each point of the object is displayed twice on the CCD matrix **Hata! Başvuru kaynağı bulunamadı..**

Shearography is a flexible method in terms of the applied impacts for exciting the reaction of internal heterogeneity (thermal, vacuum, vibration). The optimal type of impact applied is depended on the structure and material of the control object, as well as the size, position (depth of bedding), and type of the defect **Hata! Başvuru kaynağı bulunamadı..** Upon impact on the research object, the laser radiation reflected by each part of the surface also changes. These changes are detected by the system. This gives an idea of the defect's nature through its reaction on the surface. The method is implemented using a shearograph, consisting of an optical block combined with a thermal heating block, and an electronic block controlled by a PC, as shown in figure 5 **Hata! Başvuru kaynağı bulunamadı..** The optical block is placed on a tripod in close proximity to the object's surface.

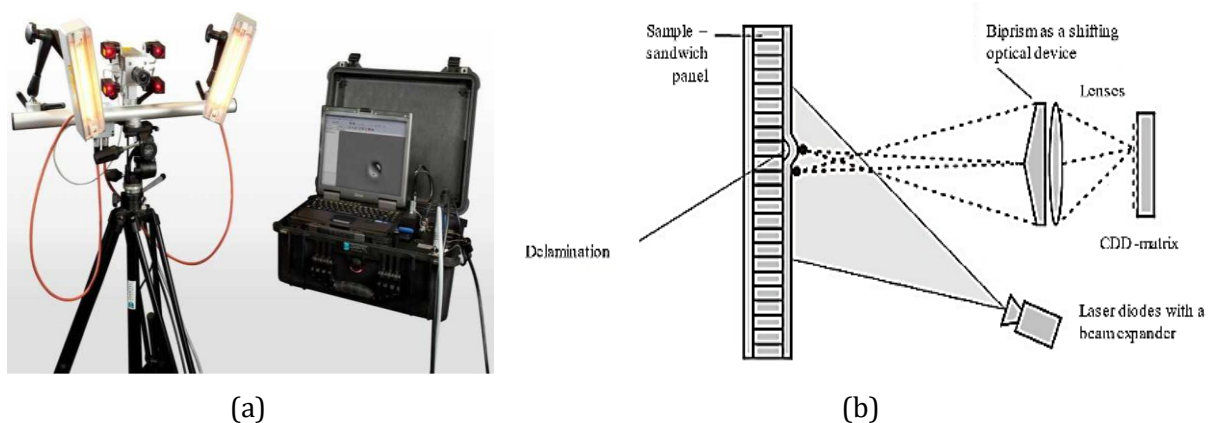

Fig. 5. Apparatus of shearography system(a) - System with automatic loading by heating; (b) - The principle of the shearograph's operation

The view area is varied depending on the type and depth of bedding of the defect (ranges from 150x150 mm to 500x500 mm). This range differs according to the reflectivity of an object and the laser system power, as well as optic's focusing range.

5. Analysis of Experimental Results

5.1 Tomography

The general view of repair zone 1, done by vacuuming and the isometry view of the 3D model are presented in figure 6. The results of the study of repair samples by means of X-ray computed tomography are given in figure 7.

The general view of zone 2, executed by a vacuum method with excess pressure, and a 3D isometric view of the model, are presented in figure 8. When examining the projections of the repair patch, areas of non-adhesion, measuring 25 mm x 35 mm, and metallic inclusions were found, as shown in figure 9.

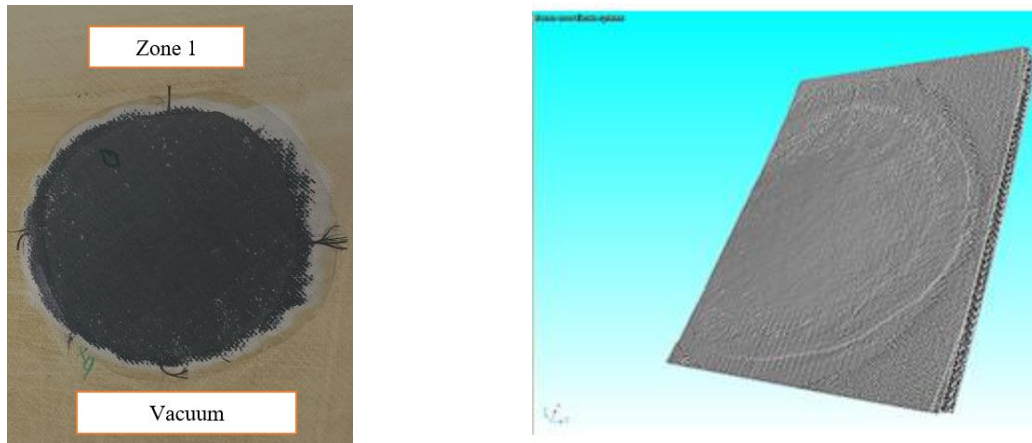

Fig. 6 – Repair patch in zone 1

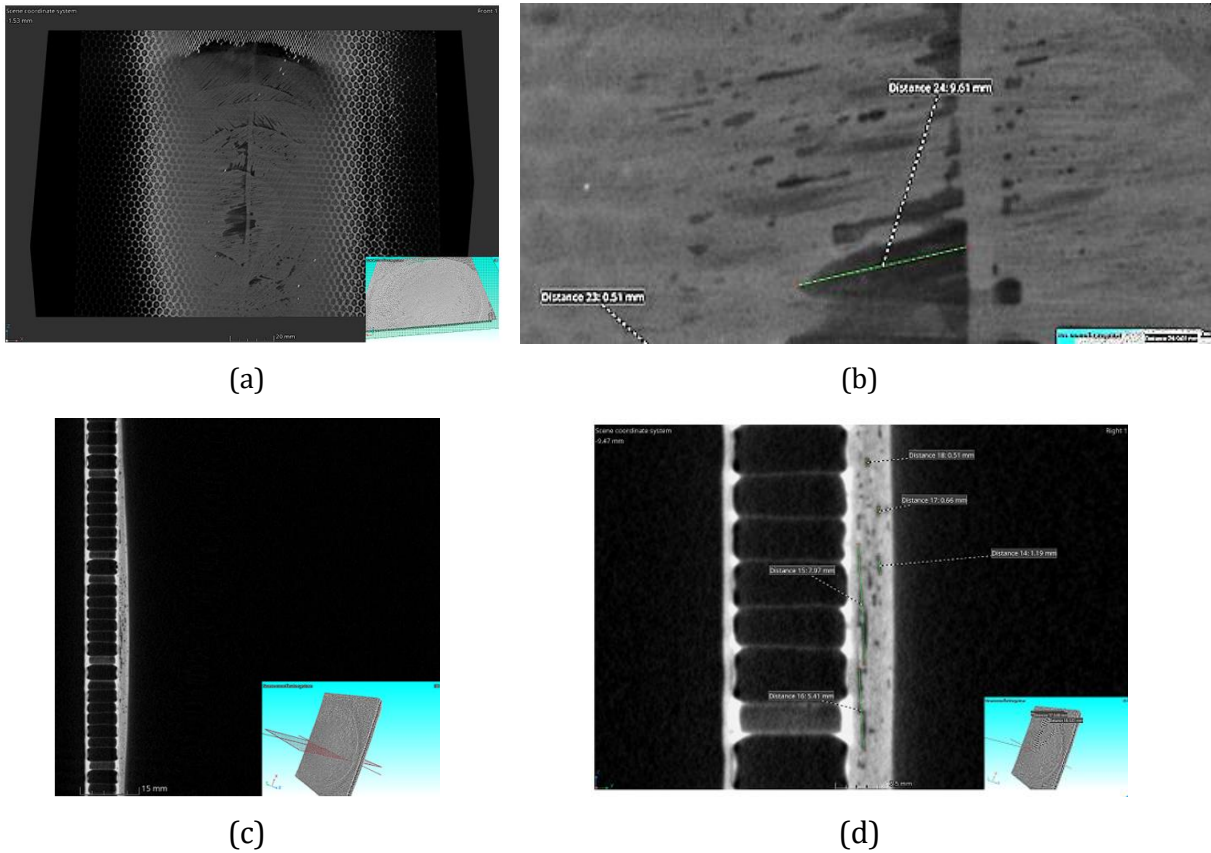

Fig. 7. Results of tomography of repair zone 1, performed by vacuum method(a) General view of the repair patch section; (b) Local repair patch section zone; (c) Side section of the repair patch; (d) Local zone of the side section of the repair patch

From the results of tomography, we can conclude that there are image defects in the form of a ring on 3D models of repair patches, associated with the capture of the axis of rotation of samples when collecting projections. These defects do not affect the research results and are merely superficial display problems. When analysing the results of tomography on the side section of the repair patch, voids related to non-adhesions up to 2.9 mm in size were found. On the sections of the repair patch, numerous defects in the form of metallic inclusions and non-adhesions were also found.

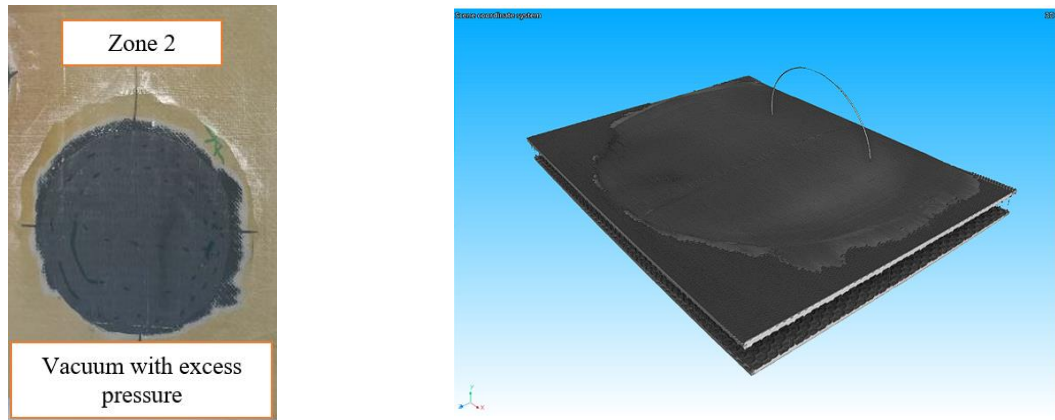

Fig. 8. Repair patch in zone 2, performed by vacuum method with excess pressure

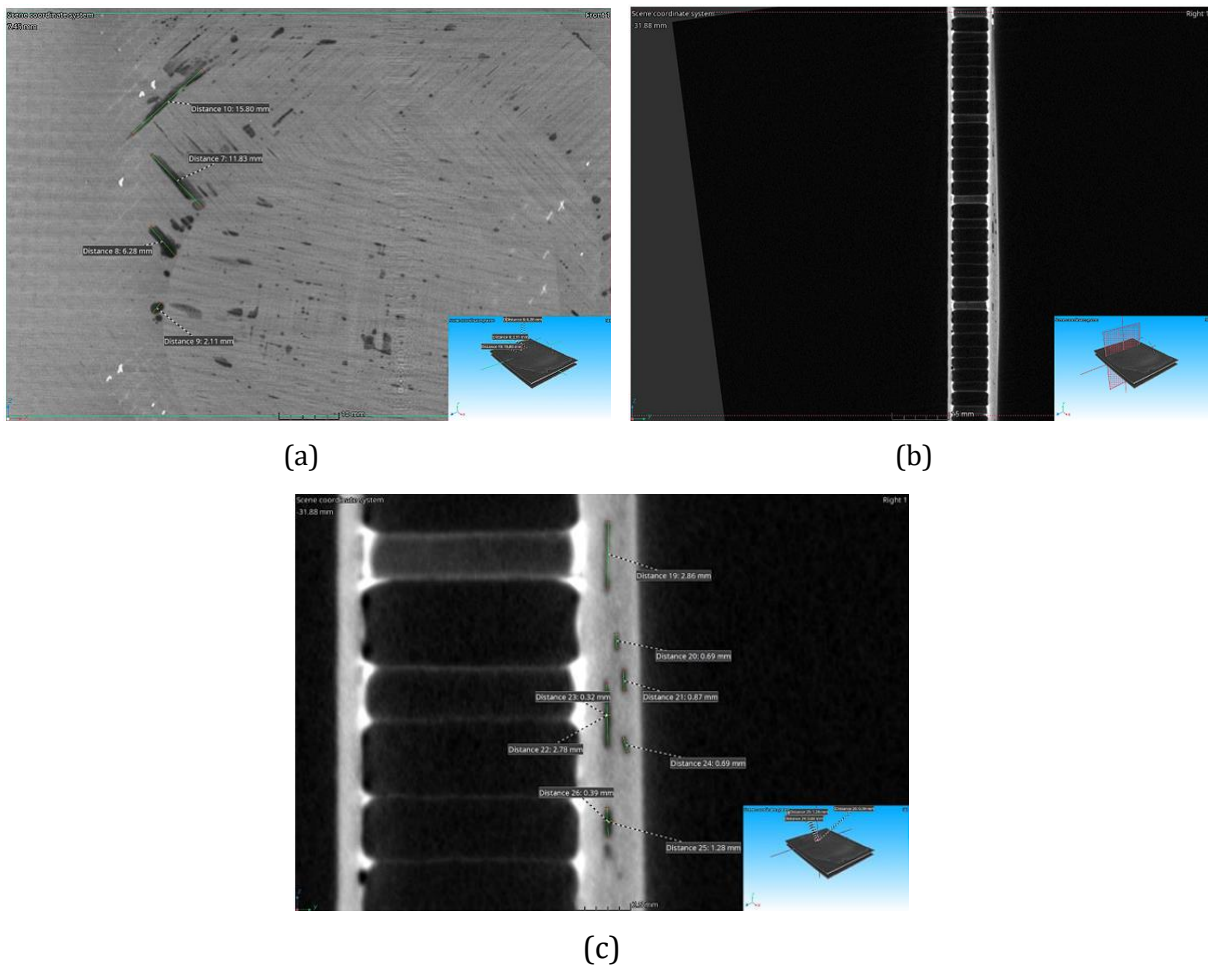

Fig. 9. Results of tomography of the patch of zone 2, performed by vacuum method with excess pressure (a) - Cross-section of the repair patch of zone 2; (b) - General view of the side section of the repair patch of zone 2; (c) - General view of the side section of the repair patch of zone 2

The general view of zone 3 with a repair performed by a vacuum method with an exceeding curing temperature and a 3D isometric view of the model are presented in figure 10. When studying the sections of the repair patch, numerous voids of sizes from 2 to 10 mm were also found, as shown in figure 11.

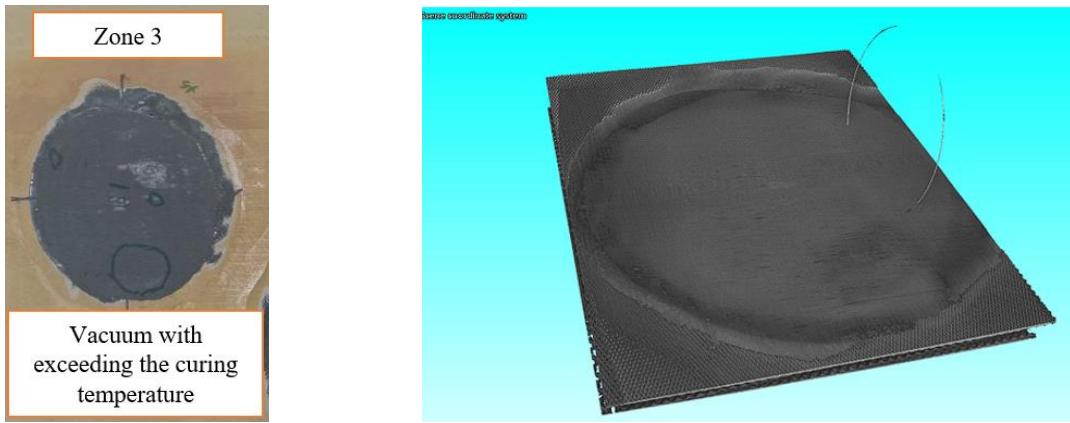

Fig. 10. Repair patch in zone 3

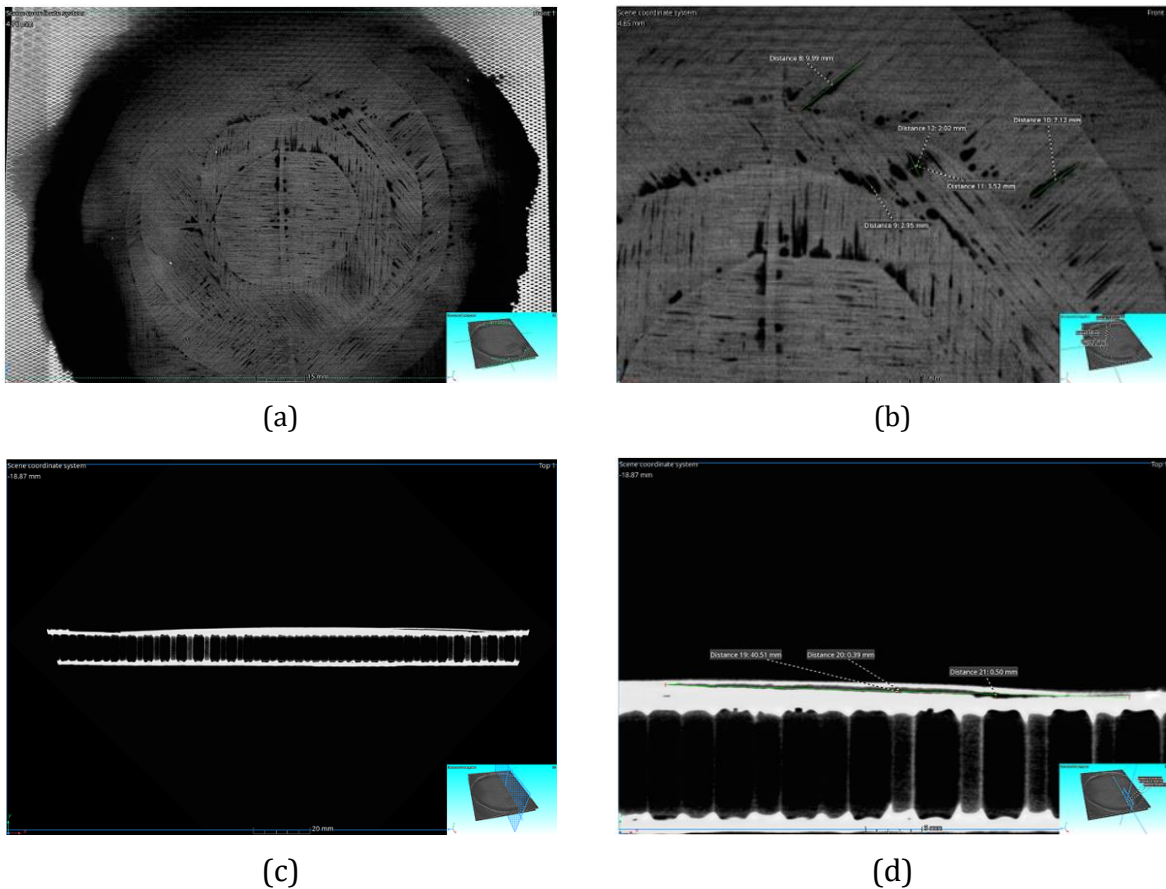

Fig. 11. Results of tomography of the patch of zone 3, performed by vacuum method with exceeding curing temperature (a) - Cross-section of the repair patch of zone 3; (b) - Local area of the cross-section of the repair patch; (c) - General view of the side section of the repair patch of zone 3; (d) - Local area of the side section of the repair patch with extensive delamination

The side section of the patch was also studied for defects. In the XY plane, in the transition area of repair patch - honeycomb filler, extensive delamination was found with a linear size of 40 mm. Based on the results of tomography, the following conclusions can be made:

- This method of NDT can identify most types of defects (down to micro-defects), which can be obtained during production and operation, with the ability to determine linear dimensions, area and depth.
- Despite all the advantages of this method, there is a significant limitation in its use – the dimensions of the samples to be studied, which are limited by the dimensions of the

tomograph. It should also be noted that this method of non-destructive testing cannot be used for on-site inspection (which shearography allows).

- Sample examination on a tomograph provides a full volume of information for assessing the quality of repair and allows you to adjust technological processes for further, higher-quality repair.
- For a detailed study of the sample, about 5-6 hours are required (including setting up the sample, setting up scan parameters, the scanning process, processing the results).

5.2 Shearography

Analysis of shearography results of a patch obtained using a vacuum method revealed characteristic features of the material structure. On the images obtained, shown in figure 12, there is pronounced layering and inhomogeneity, presumably due to the specifics of the technological process of composite material production. Defects found on shearograms indicate possible defects or uneven distribution of components within the material.

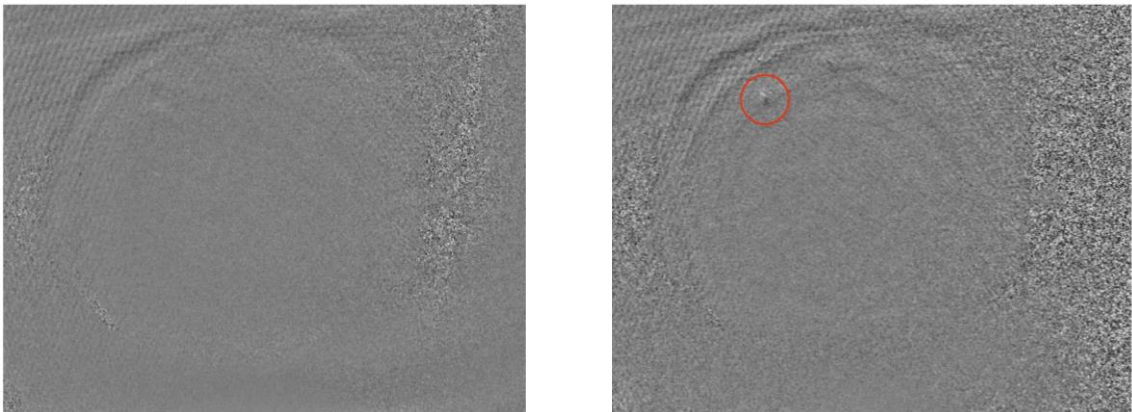

Fig. 12. Shearograms of the patch performed by vacuum method

The research of layering and inhomogeneity of the patch by shearography allows a deeper understanding of the processes of forming composite material and identifying potential problems that occurred during its production. Further analysis of the shearography results may contribute to the optimisation of technological processes and improvement of the quality of the final product.

The results of the analysis of the patch obtained by vacuum method with excess pressure demonstrated that the structure can be clearly seen on the shearograms without identified inhomogeneities and defects, as shown in figure 13. This observation testifies to the high level of quality of the patch manufacture and its homogeneity. The absence of inhomogeneities indicates that the vacuum process with excess pressure was performed in accordance with the technological requirements, which contributes to obtaining a material with a homogeneous structure.

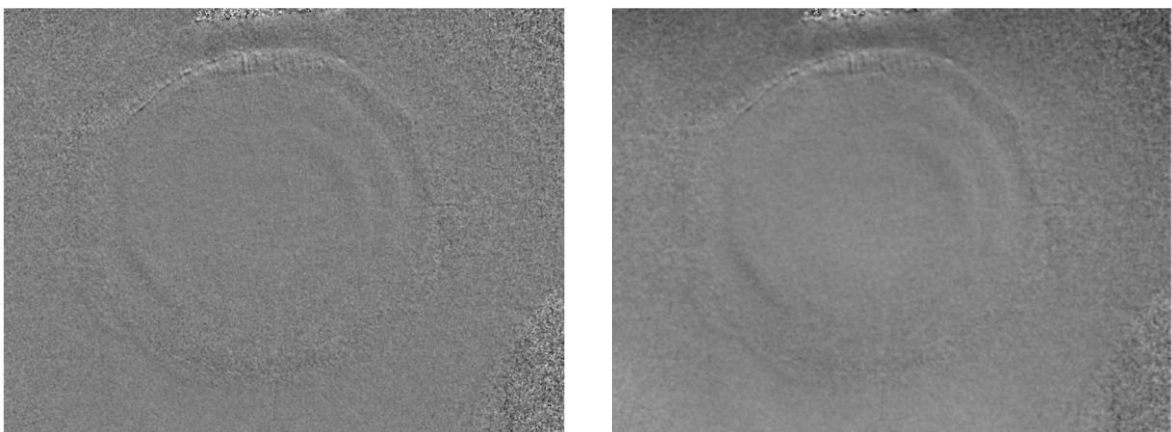

Fig. 13. Shearograms of the patch performed by excess pressure

Thus, the results of shearographic analysis confirm the high quality of the patch, distinguished by the absence of identified defects and inhomogeneities. This study is important for quality control and optimisation of production processes in the field of composite materials. The patch performed by vacuum method with exceeding the curing temperature was also studied by shearography, the results of which clearly indicate the presence of inhomogeneity in the form of delamination in the structure, indicating a violation of the technological regime of the repair process, as shown in figure 14.

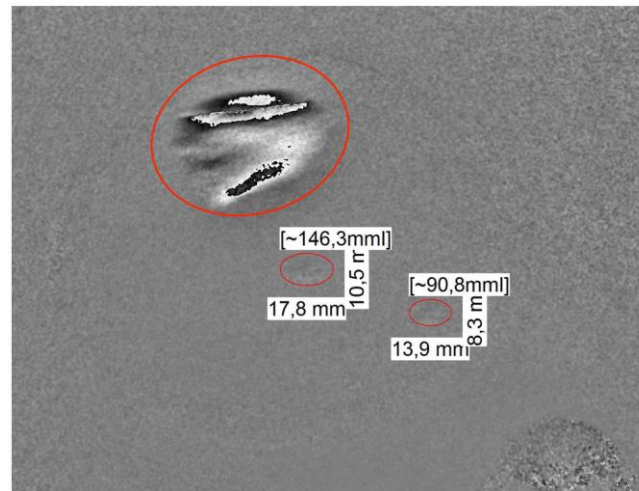

Fig. 14 – Shearograms of the patch obtained using vacuum and exceeding curing temperature

The detected inhomogeneity in the material structure, confirmed by shearographic analysis, may have a negative impact on the mechanical properties and durability of the patch.

Based on the results of shearography, the following conclusions can be made:

- With this method of non-destructive testing, it is possible to see transitions between structures (transitions from honeycomb filler to monolithic material).
- The shearography method, like the other non-destructive testing methods used, recorded extensive delamination of the repair zone 3, obtained by vacuuming with an excess curing temperature.
- With a shearograph, you can see the transition between the layers of the patch.
- Shearography requires less time for equipment calibration, the calibration mechanism is less labour-intensive.
- Shearography is a more visual method of defect detection compared to, for example, ultrasonic testing, but it does not allow classifying damage.

Based on the results of the conducted studies, the following conclusions can be made:

- Comparison of defectoscopy indications

6. Discussions

When analysing the results of the conducted studies, we can conclude:

- Zone 1: In the repair zone 1, performed by vacuum method, non-adhesions between the layers of the patch and voids formed during the curing of the resin were found. These types of defects were detected by all NDT methods used in the research. One of the factors for the formation of non-adhesions is the experience and qualification of the staff performing the repair activities, which directly affects the quality of the technological process.
- Zone 2: In repair zone 2, performed by vacuum method with excess pressure, minor non-adhesions and voids were found in the repair patch area. The linear dimensions of the non-adhesions are 2-3 mm, so it was not possible to assess defects with such geometric dimensions using the express method of NDT (shearography). The quality of the repair

performed in zone 2 can be assessed as satisfactory, with the smallest number of defects detected by the detailed method of NDT (Tomography).

- Zone 3: In repair zone 3, performed by vacuum method exceeding the curing temperature, numerous local non-adhesions in the patch area were found, including extensive delamination between the repair layers with linear dimensions of 40x40 mm. The largest defect, due to the detection of which this repair patch can be classified as defective, was determined by all NDT methods used. Smaller linear defects - only by tomography, confirming the need to use the most detailed and lengthy method of analysing the structure of repaired samples at the stage of working out repairs according to various technologies.

7. Conclusions

The following conclusions can be made from the tomography results:

- Using this NDT method, most types of defects (down to micro-defects) that can occur during production and operation can be identified. It also allows for the determination of location, linear dimensions, area, and depth of the defect.
- Shearography method is not informative in tasks of detecting small defects but can be used in tasks of surface analysis of the structure for the presence of obvious defects of relatively large sizes. The advantages of this method over tomography should be considered, the main one of which is the possibility of studying large structures on site.
- A comparative analysis is needed to evaluate the applicability and effectiveness of these NDT's on other types of samples (monolithic panels, three-layer panels of different thickness, samples with varying curvature). At the stage of refining technological processes and choosing the optimal repair strategy, tomography is necessary for a comprehensive assessment of the repair quality.
- In future, during technical maintenance of the aircraft, it is recommended to use shearography and ultrasonic testing methods.

This article makes a unique contribution to the repair of polymer composite materials in aviation, emphasising the use of adhesive technologies to repair aircraft structures on site. This minimises disassembly, reducing costs and reducing repair time. The article offers a comprehensive approach to the analysis of repair technologies and non-destructive testing (NDT) methods. An experimental study of adhesive repair of a three-layer carbon fiber panel examines in detail the various repair areas and identified defects, demonstrating the relationship between control methods and repair quality. In addition, the emphasis on staff qualifications highlights the importance of the human factor. The work offers recommendations to improve the quality and reliability of repair operations. The results of the study also emphasise the need for detailed non-destructive testing to assess the integrity of repairs, which is critical for flight safety. The practical focus of the article includes specific recommendations that enhance the reliability of processes.

Acknowledgement

The authors acknowledge that Laboratory № 3 "Modelling of composite structures" of the Centre for Aerospace Materials and Technologies of the Institute № 14 "Advanced Engineering School" and Centre of Composite Structures support this study in the Moscow Aviation Institute (MAI).

References

- [1] Pogosyan M, Nazarov E, Bolshikh A, et al. Aircraft composite structures integrated approach: a review. J Phys Conf Ser. 2021;1925(1):21-34. <https://doi.org/10.1088/1742-6596/1925/1/012005>
- [2] Amsc N, CMPS A. Composite materials handbook: polymer matrix composites materials usage, design, and analysis. 2002;3.
- [3] Zhao C, Guan ZD, Guo X. Compression performance of repaired composite stiffened panels: bolted repair and scarfed bonded repair. Mater Sci Forum. 2015;813:152-160. <https://doi.org/10.4028/www.scientific.net/MSF.813.152>
- [4] Xu J, et al. Numerical and experimental study on stiffened composite panel repaired by bolted joints under compressive load. J Appl Math Phys. 2018;6(8):1763-1771. <https://doi.org/10.4236/jamp.2018.68151>

- [5] Lupkin BV, Nitka VP. Method of repairing of assemblies made of composite materials with tubular (honeycomb) filler under field conditions. *Otkrytye Informatsionnye i Kompyuternye Integrirovannye Tekhnologii*. 2014;63:33-41.
- [6] Reznichenko VI. Особенности ремонта сотовых конструкций из композиционных материалов методом термокомпрессионного формования (Features of repair of cellular structures made of composite materials by thermocompression molding). *Инновации и Инвестиции*. 2020;11:236-240.
- [7] Préau M, Hubert P. Bonded repairs of honeycomb sandwich structures: process monitoring and quality assessment. *Proceedings of the 20th International Conference on Composite Materials (ICCM-20)*. 2015.
- [8] Ghazali E, et al. Mechanical performance of repaired sandwich panels: experimental characterization and finite-element modelling. *J Sandwich Struct Mater*. 2019;21(4):1357-1378. <https://doi.org/10.1177/1099636217716059>
- [9] Centea T, Grunenfelder LK, Nutt SR. A review of out-of-autoclave prepregs-Material properties, process phenomena, and manufacturing considerations. *Compos Part A Appl Sci Manuf*. 2015;70:132-154. <https://doi.org/10.1016/j.compositesa.2014.09.029>
- [10] Mitchell KR, et al. Nondestructive evaluation of composite repairs. *ASNT Annu Conf*. 2013;170-176.
- [11] Grunenfelder LK, et al. Effect of room-temperature out-time on tow impregnation in an out-of-autoclave prepreg. *Compos Part A Appl Sci Manuf*. 2013;45:119-126. <https://doi.org/10.1016/j.compositesa.2012.10.001>
- [12] Heslehurst RB. *Defects and damage in composite materials and structures*. Boca Raton, FL, USA: CRC Press; 2014. <https://doi.org/10.1201/b16765>
- [13] Tomblin JS, Salah L, Welch JM, Borgman MD. Bonded repair of aircraft composite sandwich structures. Federal Aviation Administration, Office of Aviation Research; 2004. Accessed April 16, 2013. Available from: <http://www.tc.faa.gov/its/worldpac/techrpt/ar03-74.pdf>.
- [14] Pieczonka L, et al. Nondestructive testing of composite patch repairs. 11th European Conference on Non-Destructive Testing (ECNDT 2014). 2014.
- [15] Blain P, et al. Artificial defects in CFRP composite structure for thermography and shearography nondestructive inspection. *Fifth Int Conf Opt Photon Eng*. 2017;10449:562-571. <https://doi.org/10.1117/12.2271701>
- [16] Dattoma V, et al. Ultrasonic and thermographic studies for CFRP inspections with real and simulated defects. *Mater Today Proc*. 2021;34:224-234. <https://doi.org/10.1016/j.matpr.2020.02.915>
- [17] Cheng L, et al. Comparison of nondestructive testing methods on detection of delaminations in composites. *J Sensors*. 2012;2012(1):408-437. <https://doi.org/10.1155/2012/408437>
- [18] Titov PA, et al. Способ ремонта конструкций из полимерных композиционных материалов (Method of repairing structures made of polymer composite materials). Patent 2740214 USA. Req. 19.03.2020. Published 12.01.2021.
- [19] Vilents VP. Портативное устройство для ремонта изделий из полимеров (Portable device for repairing polymer items). Patent RU2089393C1. Req. 25.04.1995. Published 10.09.1997.
- [20] Vilents VP. Способ клеевого ремонта аэродинамических поверхностей летательных аппаратов (Method of adhesive repair of aerodynamic surfaces of aircraft). Patent RU2754706C1. Req. 07.10.2020. Published 06.09.2021.
- [21] Vilents VP. Способ ремонта изделий из полимерных композиционных материалов с односторонним доступом в зону ремонта (Method of repairing items made of polymer composite materials with one-sided access to the repair zone). Patent RU2723868C1. Req. 30.07.2019. Published 17.06.2020.
- [22] Vilents VP. Способ ремонта тонкостенных конструкций (Method of repairing thin-walled structures). Patent RU2181083C2. Req. 26.06.2020. Published 10.04.2002.
- [23] Vollen MW, et al. Application of shearography techniques for vibration characterization and damage detection in sandwich structures. *Meeting Proc RTO-MP-AVT*. 2005;124:21-1.
- [24] Waldner S, Goudemand N. Quantitative strain analysis with image shearing speckle pattern interferometry. *Interferometry in Speckle Light: Theory and Applications*. Springer Berlin Heidelberg; 2000:319-326. https://doi.org/10.1007/978-3-642-57323-1_40
- [25] Polymer composites. Shearography of polymer composite materials, sandwich core materials and filament-wound pressure vessels: (Russian State Standard) ГОСТ Р 56795-2015. 2016. Req. 01.01.2017. М.: Standartinform. P. 23.
- [26] Nevatecnology: official website. Moscow; 2022. Available from: <https://nevatec.ru/>. Accessed March 19, 2024.